

the **inspectionsgroup**inc.

Permits and Compliance

A reference guide when applying for Electrical, Building, Plumbing, Gas and Private Sewage Permits



Permits and Compliance is an information guide produced and published by The Inspections Group Inc. This guide is intended to be for quick reference only. It is not intended to answer every question or anticipate every need of a permit applicant, home owner or builder. All persons planning work that is governed by a code in the Province of Alberta should first contact their local municipal authority for direction and requirements for permits in their locality.

The diagrams and forms contained herein are samples only and do not represent the only way, method or materials that will achieve code compliance.

Many employees of The Inspections Group Inc. contributed with helpful technical and format suggestions.

Permits and Compliance Fourth Edition April 2017. All rights reserved. No portion of this book may be copied or reproduced in any manner.

EDSON

Phone: 780 723 4923
Fax: 780 723 3991

EDMONTON

Phone: 780 454 5048
Fax: 780 454 5222

COLD LAKE

Phone: 780 594 4301
Fax: 780 594 3720

INDEX

PAGE

Corporate Values	1
Development Permits	2
Building Permits	2
Other Types of Permits	3
Impact of Permits Missed	3
New Home Warranty Information	4
What You Need Before Applying for a Building Permit	4
How to Apply	4
Homeowner vs Contractor	5
Permit Application Information	6
Required Information on Building Drawings	7
Commercial Project Guideline	10
Professional Involvement Determination Checklist	10
Partial Professional Involvement Checklist	11
Building Application Requirements Checklist	12
PSDS Application Requirement Checklist	15
Private Sewage Permit Application Requirements	16
Minimum Setbacks for Private Sewage Systems	18
After the Permit is Issued	19
Inspections	20
Inspection Stages by Permit Type	20
Compliance	22

REFERENCE SECTION

This section contains helpful information and diagrams that cover some of the more common permit and compliance situations.

Bedroom Window Egress	24
Landing with Guard Rail and Stair	25
Wheel Chair Ramp	25
Guards and Handrails	26
Wood Stove Installation	26
Uncovered Deck Construction	27
Garages	28
Garage, Shed and Accessory Building	29
Manufactured Homes	31
Relocated Manufactured Home	32
Basic Residential Building Foundations	33
Building Permit Application Guideline	36
Prescriptive Requirements General Information Summary Zone 7A	37
Prescriptive Requirements General Information Summary Zone 7B	38
Prescriptive Requirements Foundation Information	39
Air Barrier System Information	40
Trap Venting	41
Plumbing Rough-ins (Diagram)	42
Plumbing a Kitchen Sink (Diagram)	43
Open Discharge (Diagram)	44
Septic Field (Diagram)	45
Septic Mound (Diagram)	46
Propane Clearances (Diagram)	47
Natural Gas Service Riser and Meter Set Connection (Diagram)	48
Natural Gas Meter Set with Connection to Secondary Riser (Diagram)	49
Electrical Residential Aerial Service Attachment (Diagram)	50
Electrical Residential Aerial Service Installation (Diagram)	51
Electrical Common Branch Circuits (Diagram)	52
Electrical Residential Underground Service Installation (Diagram)	54

EDSON

Phone: 780 723 4923
Fax: 780 723 3991

EDMONTON

Phone: 780 454 5048
Fax: 780 454 5222

COLD LAKE

Phone: 780 594 4301
Fax: 780 594 3720



Service

Friendly advice. Complete inspection services. Quick turnaround time.

Mission Statement

The Inspections Group Inc. is committed to providing optimum compliance monitoring services with utmost integrity.

- Inspection agency of choice
- Consistently exceed customer expectations

CORPORATE VALUES

Ethical

Conduct our business with integrity in the communities we serve.



Proactive

Identify contractor and municipal expectations and deliver on commitments and communications in a timely manner.



Growth & Innovation

Challenge the status quo with new ideas and continuously improving our people, services and processes.



Teamwork

Share knowledge through communication that promotes continuous learning.



Service Excellence

By listening to our customers and their needs, consistently deliver extraordinary service that exceeds our customer's expectations.



We Strive To Provide Our Customers with Expertise and Guidance at an Unmatched Level of Excellence

The Inspections Group Inc. was incorporated in 2001. The Inspections Group Inc. provides compliance monitoring services under the Alberta Safety Codes Act for five disciplines: building, electrical, plumbing (including private sewage disposal systems), gas and fire. The Inspections Group Inc. also provides permit issuance and inspection services for residential, commercial and industrial sites in four disciplines throughout the Province of Alberta.

PROUD LEADERS IN COMPLIANCE MONITORING SINCE 2001

EDSON

Phone: 780 723 4923
Fax: 780 723 3991

EDMONTON

Phone: 780 454 5048
Fax: 780 454 5222

COLD LAKE

Phone: 780 594 4301
Fax: 780 594 3720

DEVELOPMENT PERMITS

A development permit essentially regulates how a property is used or improved. Consideration has to be given to neighbors, zoning and existing construction to maintain harmony in communities.

A development permit approves the location, size and use of a building. Development permits and approvals need to be obtained for new construction, renovations, businesses and changes to how a building will be used.

A development permit may also be subject to conditions, such as utility rights of way, restrictive covenants, proximity to roads and highways. For more information contact the Planning and Development Department of your local Municipality.

You must have a Development Permit before you apply for a Building Permit. There are some municipalities that have parallel application processes. Please check with your municipal office if you are unsure what your municipality's process are.

BUILDING PERMITS

Building permits regulate how a building or other structure is built. The intent of The Alberta Building Code is to ensure the health and safety of the occupants of a building or construction. This Code establishes minimum requirements to be met in the Province of Alberta.

Most construction projects; including some renovations, require permits under the Alberta Safety Codes Act. Depending on the Municipality you live in, The Inspections Group Inc. may provide some or all permit services for your area.

Some minor types of renovations (e.g. replacing doors or windows in the same size frames, re-shingling roofs, etc.) may not require permits. Buildings under 10 sq. m. (110 sq. ft.) do not require a permit. In some municipalities, decks less than 24 inches in elevation from the finished grade do not require a permit to build. If you are not sure if you need a permit for your project, call your local Municipality or The Inspections Group Inc..

It is important to apply for permits **PRIOR** to beginning the work. This allows for a Safety Codes Officer to review your project and help make you aware of code requirements that may have a significant impact on your proposed project. Speaking with a Safety Codes Officer before you build may potentially save you thousands of dollars. We would highly recommend you take advantage of this service that we provide.

EDSON

Phone: 780 723 4923
Fax: 780 723 3991

EDMONTON

Phone: 780 454 5048
Fax: 780 454 5222

COLD LAKE

Phone: 780 594 4301
Fax: 780 594 3720

OTHER TYPES OF PERMITS

When your project includes services such as electrical, plumbing and gas, additional permits will be required.

The Alberta Safety Codes Act requires that installations of electrical, gas and plumbing, (including private sewage disposal systems) be covered under a permit and that they must be inspected.

The Inspections Group Inc. is accredited to issue permits and provide compliance monitoring in five disciplines under the Alberta Safety Codes Act. Our qualified Safety Codes Officers will also check materials and appliances for compliance with recognized standards.

Our Safety Codes Officers will verify that proper methods of assembly are used and examine for proper identification before providing acceptance of installations.

IMPACT OF PERMITS MISSED OR IGNORED

It is important that work on buildings and properties be properly permitted. The Safety Codes Act and its pursuant codes (i.e. Building, Electrical, Plumbing and Gas etc.) were put in force to protect public safety by establishing a minimum standard to be met. When permits are missed or ignored, serious consequences may result such as compromising fire protection requirements within a building or compromising the project so much so that an unsafe condition is created. This can have enforcement action undertaken through an "Order to Comply". Less serious is the issue of having to put permits in place for completed work, days, weeks, even months later (usually because of a property sale that someone never anticipated). There is also a financial impact; permits will cost more in the future than they will today.

Energy efficiency requirements have been adopted in the Alberta Building Code 2014. There are prescriptive measures in Division B Section 9.36. Alternative designs are permitted but you will need a professional to design a custom option via the trade-off or performance modelling methods. The energy efficiency requirements consider how your building envelope, lighting, and mechanical systems in your home contribute to the energy efficiency of your building. These changes will not require new materials or systems that are not in use in current construction, but rather look at how those materials and systems are put together.

Energy Code is adopted and enforce now. The efficiency requirements are dependent on the climate zone that your project is located in.

Permits applied for prior to November 1, 2016 are NOT required to comply with the energy code requirements. If you purchase a manufactured home, proof that the home was manufactured prior to November 1, 2016 will exempt that building from the energy code requirements.

Buildings or work that did not have permits in place and future new construction will have to meet all new requirements when a permit is purchased.

NEW HOME WARRANTY INFORMATION

Effective February 1, 2014, The New Home Buyers Protection Act came into force. This Act requires that proof of warranty is submitted with every permit application. If a homeowner is building his/her residence, they are required to submit proof that they have received permission for the warranty to be waived. **A building permit will not be issued without this paperwork.** Applications without proof of warranty, or proof of exemption, will be returned immediately and cannot legally be issued. For more information please visit www.municipalaffairs.gov.ab.ca/alberta_home_warranties.cfm

WHAT YOU NEED BEFORE APPLYING FOR A BUILDING PERMIT

Before applying for a Building Permit (except for a garage, shed, or accessory building) make sure you have the following:

- A copy of your approved Municipal Development Permit.
- The correct municipal address or the legal description of the property (lot, block, plan, section, township, range).
- At least two complete sets of plans for your building project including:
 - Site plan
 - Floor plan
 - Elevation drawings
 - Cross-section drawings
 - Mechanical information
 - Electrical information
 - Professional endorsement (e.g. Engineer or Architect seal and signature, when required)
 - Roof truss layouts (e.g. manufactured/engineered systems)
 - Floor joist layouts (e.g. manufactured/engineered systems)

All construction plans will be reviewed by a qualified professional to verify that they meet the requirements of regulations adopted under the Safety Codes Act. Provided everything in your plans meets the requirements, a Building Permit may be issued.

HOW TO APPLY

- Call our office, at 1 866 554 5048 (toll free) from anywhere in Alberta for a free consultation, to verify the appropriate permit issuer in your Municipality and to obtain the correct application form. In the Edmonton area, please give us a call at (780) 454 5048 or visit our office located at 12010-111 Avenue, Edmonton, Alberta. You can also visit our Edson office at 4905 4th Avenue Lower Level, Edson Alberta or call (877) 723 4923. In Cold Lake please call 780 594 4301 or visit 110, 4910 50 Avenue.
- Fill out the correct application form.
- Check with your Municipality or The Inspections Group Inc. to determine where to submit the completed form with the necessary plans and supporting documents as per requirements.

EDSON

Phone: 780 723 4923
Fax: 780 723 3991

EDMONTON

Phone: 780 454 5048
Fax: 780 454 5222

COLD LAKE

Phone: 780 594 4301
Fax: 780 594 3720

HOMEOWNER VS. CONTRACTOR

A permit issuer may issue a permit:

DISCIPLINE	HOMEOWNER	CONTRACTOR
Building	<p>to an owner who resides in a single family residential dwelling for the installation of building systems in the dwelling</p> <p>commercial projects are NOT issued as homeowner permits, even if the property owner applies for the permit. Homeowner permits are limited to single family dwellings and their ancillary structure(s).</p>	to an owner's agent
Electrical	<p>to an owner who resides in a single family residential dwelling where the electrical system serves that dwelling</p> <p>to an owner of a farm building* served by a single phase electrical system</p>	to a master electrician
Gas	<p>to an owner who resides in a single family residential dwelling if the gas system serves the dwelling</p> <p>to an owner of a farm building* if the gas system serves the farm building</p>	to a journeyman gasfitter
Plumbing	<p>to an owner who resides in a single family residential dwelling if the plumbing system serves the dwelling</p> <p>to an owner of a farm building* if the plumbing system serves the farm building</p>	to a journeyman plumber
Private Sewage	<p>to an owner who resides in a single family residential dwelling for any private sewage system if the private sewage disposal system serves the dwelling</p> <p>to an owner of a farm building* for any private sewage system if the private sewage disposal system serves the farm building</p>	to a certified installer

*Farm building – means a building located on agricultural land as defined in the *Agricultural Operation Practices Act* that is occupied for an agricultural operation as defined in the *Agricultural Operation Practices Act*. The categorization of a property as a farm building is done by the municipality. Buildings built on farm land, which is NOT for farm use, but personal use still requires permits for the construction.

Usually homeowner permits require more inspections and cost more.

PERMIT APPLICATION INFORMATION THAT IS REGULARLY OVERLOOKED

Cost of Installation (Labor & Materials): Sometimes permit fees are calculated on the work being done by square footage, cost of the project or number of fixtures.

Owner information: It is a requirement under the Permit Regulation to obtain the property owner's name and mailing information. Obtaining complete and accurate owner information is imperative. **The owner is responsible for ensuring the work complies with the Safety Codes Act.** A Permit Services Report is issued to the owner when the permit is closed and alerts the owner as to the final outcome of the inspection process. This may require the owner to take additional action. It is imperative that we are able to contact the owner by mailing address, phone, fax and/or email. Every effort must be made to make sure the owner receives the Permit Services Report (PSR).

Owners are also contacted in the event of a 'No Entry' inspection, when a variance is issued or if the permit expires.

Project Location: It is a requirement under the Permit Regulation to obtain the address where construction will take place. It is important to clearly state the municipality where the project is located.

Street Address: Required for an address in any municipality other than rural addresses in a County or a Municipal District. A legal land description is required for rural locations.

Description of Work: A requirement under the Permit Regulation is to describe the undertaking or portion of the undertaking governed by the permit, including information satisfactory to the permit issuer regarding the technical nature and extent of the undertaking. A description of work should always be included so that the Safety Codes Officer knows what they will be inspecting when they are on site.

Engineer Stamped Drawings: Construction that requires engineering is required to have engineer stamped drawings submitted with the application. Construction assemblies that normally require engineering: any structural steel buildings; pole sheds; grade beam and pile foundations; retaining walls with a height over 4 feet and tall wall construction that does not follow the STANDATA.

Hydronic Heat Systems: These systems are required to be installed in conformance with Div. B Art. 9.33.4.1.. Alberta Municipal Affairs has released STANDATA that identifies how hydronic heat systems can be verified for compliance to the code. This takes the form of a design by either a certified hydronic designer or mechanical engineer. Most Plumbing wholesalers employ a certified hydronic designer(s) that can do the required design for your system. This is required information for the installation of hydronic heat systems.

Solid Fuel Appliances: These devices require a copy of the manufacturer's installation instructions to be provided. If you have not purchased or decided on a particular make and model at the time of installation, it is critical that these are on-site for the inspector to review at the time of inspection. Please note there is a CSA standard that allows the installation of uncertified appliances. This standard has strict guidelines. If you need further information please contact us to discuss your specific installation.

Deck Drawings: A deck is a relatively straightforward construction, however, if incorrectly sized or spaced materials are used, it can create a great deal of work to repair at the time of inspection. Accurate information for these simple projects help our plan reviewers provide you with information that identifies any potential changes that may need to be made prior to construction so that you can achieve compliance with the code.

REQUIRED INFORMATION ON BUILDING DRAWINGS FOR A RESIDENTIAL BUILDING PERMIT:

Changes in the Alberta Building Code 2014 have a number of impacts on residential construction, the most impactful changes to the average home have been:

Energy code

- compliance with prescriptive measures require detailed information on the submitted plans to review for compliance
- trade-off designs require detailed information on the trade-off process that is being used for the project
- performance modelling requires professional stamped drawings with the performance model and detailed construction details for the proposed construction
- see detailed information sheets for Section 9.36 of the Alberta Building Code on pages 36 through 40 of this guide

Radon Gas Mitigation

- requires a 4" washed rock layer and 4" roughed-in connection for a radon gas mitigation system

Additional Smoke detectors

- required in every bedroom, in every corridor serving a bedroom, and on every floor level

NAFS Window Standard adoption

- the manufacturer for the windows in your building will be required to submit a window design layout that demonstrates the windows conform to the NAFS standard
- Windows installed **MUST** keep the labels on them until the final inspection of the building is completed to demonstrate that the correct window was installed in the locations specified by the manufacturer

Basement Bedroom Window Well Requirements

- clearance of 760mm or 2' 5-7/8" is required for basement bedroom window wells
- If the window swings out, the clearance must extend past the arc of the window opening

1. Site Plan

Show the actual dimensions of the legal property and the location of the building in relation to the property lines and all other buildings or structures on the property. Dimensions must be shown for spatial separation from property lines and other buildings.

2. Foundation Plan

Include the following information:

- Width and depth of footing, strength of concrete, and size of reinforced steel used
- Width and height of concrete walls including interior insulation and wall cladding
- Size and depth of concrete pads used to support structural members
- Type of damp proofing used below grade on foundation
- Weeping tile and sub surface water disposal method
- Main floor joist layout including details of beams, columns and teleposts (size, spacing etc.)

Note: The following types of foundation construction must be designed and inspected by a Professional Engineer licensed to practice in the Province of Alberta:

- Pile foundations (concrete, wood or steel)
- Pile and grade beam (exception: garages not exceeding 55 sq. meters (approx. 24' X 26'))
- Preserved wood foundations if not built to CAN/CSA-S406
- Shallow foundations that are less than 4 ft. below grade or less than frost penetration

Should you be using any one of the above construction methods, detailed drawings for these types of foundations should be designed, stamped and sealed by an Engineer before issuance of your building permit.

3. Floor Plan

For each floor level including the basement, the size and use of all rooms and floor areas are to be identified. (i.e. kitchen, bedroom, furnace room, garage, etc.).

Note: If you are utilizing a manufactured/pre-engineered product such as: i-joist, truss joist or any other pre-engineered product including beams, the manufacturer's designed layout must be submitted.

4. Elevation View

Each face of the building (north, south, east and west) must be drawn to show the size and location of each opening (windows and doors) and the finished grade elevation must be included. The type of exterior finishing is normally identified on these drawings.

5. Cross Section

This drawing describes the construction details and dimensions of various components of the buildings construction (i.e. foundation, floor, basement floor, interior walls, exterior walls, and roof).

For example: a typical exterior wall may consist of the following: horizontal vinyl siding, building paper, 3/8 OSB exterior sheathing, 2x6 SPF # 2 studs at 16 inches on center, R-20 batt insulation, 6 mil CGSB polyethylene vapor barrier, 1/2 inch gypsum board (painted).

6. Mechanical and Electrical Information

Information describing the type of heating and ventilation system that will be installed in the dwelling is to be shown. Note that Hydronic Radiant floor heating systems require an engineered design that must be submitted if you are installing such a system. These systems also require ventilation systems be installed to provide adequate air changes within a building.

Electrical lighting, receptacles, service location and smoke alarm(s)/carbon monoxide alarm(s) are to be included on floor plans.

7. Summary

Designs created by an applicant must be legible, drawn to scale and be of sufficient clarity and detail to enable a Safety Codes Officer to determine that the construction is in compliance with safety standards and identify any potential infractions prior to construction beginning.

As it is impossible to cover all designs and site conditions using standard building practices as outlined in Part 9 of the Alberta Building Code, any design which cannot be checked using the minimum standard of the Alberta Building Code must be designed and reviewed by a Professional Engineer or a Registered Architect licensed to practice in the Province of Alberta.

A Safety Codes Officer may refuse to issue a permit if the work proposed does not meet the safety standards and regulations adopted under the Safety Codes Act, or if the issuer is not satisfied with the quality, accuracy and adequacy of the information provided by the applicant in support of the application.

In summary, this document is intended as general information only and may not address all situations that may arise in the process of preparing construction drawings, or conditions encountered on the site during construction. It is our intention that this will act only as a guide to assist you in obtaining a building permit in a quick and efficient manner.

A Building Safety Codes Officer will stamp the drawings “examined” during the plan review phase. One set of these drawings must be present at the project site during construction.

COMMERCIAL PROJECT GUIDELINE

For commercial projects that require full professional involvement, it is recommended that you work in conjunction with the Architect(s) and Engineer(s) you have retained to design your building. The information provided here is an aid to help determine if the commercial/industrial project you are planning requires full or partial professional involvement and to provide assistance in determining what needs to be provided for projects that only have partial professional involvement. Before undertaking a commercial project it is recommended that you consult with your local Safety Codes Officer.

PROFESSIONAL INVOLEMENT DETERMINATION CHECKLIST

Step 1) Occupancy

Group A - Assembly

Group B - Care or Detention

Group C - Residential

Type of Occupancy - _____

Group D - Business and Personal Services

Group E - Mercantile

Group F - Industrial

Step 2) Building Height

Number of Stories - _____

4 or more stories – requires **full professional involvement**

Up to 3 stories – proceed to Step 3

Step 3) Building Area

If project is a new building

Area of largest floor _____ m2

If project is an addition

Area of addition only _____ m2

If project is an addition and renovation of an existing building

Total area of addition _____ m2

Renovation area _____ m2

If project is a renovation

Area of renovation only _____ m2

TOTAL BUILDING AREA

_____ m2

If you have any questions regarding your project or use of information provided here, please contact our office to consult with a Safety Codes Officer regarding your project.

If total area exceeds the areas listed in the following chart, **full professional involvement is required.**

If area does not exceed areas listed below, use **the partial professional involvement checklist.**

EDSON

Phone: 780 723 4923
Fax: 780 723 3991

EDMONTON

Phone: 780 454 5048
Fax: 780 454 5222

COLD LAKE

Phone: 780 594 4301
Fax: 780 594 3720

Building area is calculated based upon the footprint of the building/the area of the site that the building will cover.

Group A	1 story	300 m2 (3229 ft2)	Group D	1 story	500 m2 (5382 ft2)
	2 story	200 m2 (2153 ft2)		2 story	250 m2 (2691 ft2)
	3 story	100 m2 (1076 ft2)		3 story	165 m2 (1776 ft2)
Group B	1 story	300 m2 (3229 ft2)	Group E	1 story	500 m2 (5382 ft2)
	2 story	200 m2 (2153 ft2)		2 story	250 m2 (2691 ft2)
	3 story	100 m2 (1076 ft2)		3 story	165 m2 (1776 ft2)
Group C	1 story	400 m2 (4305 ft2)	Group F	1 story	500 m2 (5382 ft2)
	2 story	200 m2 (2153 ft2)		2 story	250 m2 (2691 ft2)
	3 story	130 m2 (1400 ft2)		3 story	165 m2 (1776 ft2)

PARTIAL PROFESSIONAL INVOLVEMENT CHECKLIST

1) Drawings to be submitted for all projects

Site Plan

- site plan submitted (showing property lines, streets, north arrow etc.)
- not applicable for interior renovation, tenant improvement etc.

Foundation Plans (Structural Drawings)

- concrete wall on strip footing below frost line (engineering not required)
- stamped and signed engineered drawings for all other foundations (concrete, steel or screw piles, slab on grade, shallow foundations etc.)
- not applicable for interior renovation, tenant improvement etc.

Tall Walls Drawings (Structural Drawings – Wood Structures only)

- stamped and signed drawing by engineer
- not applicable when walls are 12 feet or less in height

Roof Truss Drawings (Wood Structures only)

- stamped and signed drawings by engineer or manufacturer's drawings
- not applicable when no roof trusses being installed

Electrical Drawings

- submitted drawings
- not applicable when no electrical work being done

Hydronic Heating Plans (Water used as heating medium, Boilers used to heat water)

- stamped and signed drawing by engineer or certified engineering technologist or certified hydronic designer (need certification number). A ventilation system is required with hydronic heating system.
- not applicable for forced air system, radiant heaters etc.

Floor Joist Drawings (Wood Structure only)

- stamped and signed drawings by engineer or manufacturer's drawings
- not applicable when no floors being installed

Elevation Drawings

- submitted drawings
- not applicable for one story interior renovation or tenant improvement

Cross Section Drawings

- submitted drawings
- not applicable for one story interior renovation or tenant improvement

Mechanical Drawings

- submitted drawings
- not applicable when no mechanical work being done

Floor Plans

- submitted drawings (showing rooms, dimensions, doors, windows etc.)

2) Buildings requiring professional involvement in addition to the drawings listed above**Fabric Covered Building Drawings**

- stamped and signed engineer drawings
- not applicable

Pole Shed Building Drawings (Wood Structure vertical members wider than 2 feet on center)

- all pages stamped and signed by engineer submitted
- not applicable

Pre-Engineered Steel Building or Concrete Building Drawings

- stamped and signed engineer drawings
- not applicable

BUILDING APPLICATION REQUIREMENTS CHECKLIST**Hot Tubs/Swimming Pools**

- site plan with the location and dimensions of tub/pool
- hot tub cover certification conforming to ASTM F1346-91
- location of fence around pool

Decks

- site plan
- plan view
- cross section view or sample plan with dimensions filled in

Woodstoves (includes Fireplaces, Pellet and Coal Stoves)

- floor plan indicating room dimensions and clearances of stove
- manufacturer's installation instructions
- references to certification listing

Basement Developments and Minor Renovations

- floor plan showing layout of new walls, bathrooms, bedrooms, windows, and doors
- has the PSDS system been sized for more bedrooms?
- window well size serving bedrooms

Manufactured Homes (mobiles)

- site plan
- foundation requirements:
 - wood blocking is acceptable (must be pressure-treated wood within 6" of grade)
 - any other foundation may/will require a structural engineered stamped plan
- floor plan
- 4 elevation views (north, south, east and west)
- C.S.A. number
- Alberta Municipal Affairs number
- serial number
- proof of deformation resistant building (built on steel frame)

Modular Homes, RTM or Relocated Buildings

- site plan
- floor plan
- foundation requirements:
 - a full basement or frost wall foundation is acceptable
 - any other foundation may/will require a structural engineered stamped plan
 - window well size(s) serving bedrooms
 - radon mitigation system rough in details
- 4 elevation views (north, south, east and west)
- C.S.A. number
- Alberta Municipal Affairs number
- serial number

Secondary Suite

- mechanical plan indicating separate heat system and ductwork installations
- floor plan
 - separate egress/exit facility from primary residence
 - window well size(s) serving bedroom(s)
 - kitchen range ventilation to the exterior
 - drywall separation between secondary and primary suites
- is this unit being added to row housing?

Duplex/Row-Housing (up to 4 units per building)

- site plan
- foundation plan
- floor plan
 - any decks or front porch construction details
 - window sizes
 - location of smoke/carbon monoxide alarms
- 4 elevation views (north, south, east and west)
- firewall/party wall construction details
- presence of any secondary suites (see secondary suites notes above)
- roof truss layouts
- manufactured floor joist layouts
- engineered stamped drawing for attached garage foundation if it is pile and grade beam
- indicate if there will be secondary suites

Single Family Dwellings and Additions

- site plan
- floor plan(s)
- window well size(s) serving bedroom(s)
- radon mitigation system rough in details
- foundation requirements:
 - a full basement or frost wall foundation is acceptable
 - pile and grade beam or any other foundation will/may require a structural engineered stamped plan
 - window well size(s) serving bedrooms
 - radon mitigation system rough in details
- elevation views
- roof truss layouts
- manufactured floor joist layouts
- engineered stamped drawing for attached garage foundation if it is pile and grade beam
- window manufacturer design layouts
- energy code details on method chosen and construction details for that option

One Room Additions and Sunrooms

- site plan
- floor plan
- foundation plan
- elevation views
- cross section view
- if it is a manufactured sunroom; supplier's full product information is required

Garages/Sheds/Storage Buildings

- site plan
- plan view
- 4 elevation views (north, south, east and west)
- building cross section
- roof truss information (optional - could be submitted later)
- window manufacturer information
- foundation requirements:
 - frost wall foundation or 55 sq. m. (596 sq. ft.) concrete slab are acceptable
 - any other foundation will require a structural engineered stamped plan
- wall requirements:
 - walls up to 12 feet in height are acceptable
 - walls over 12 feet will require an engineered stamped plan

Demolition

- site plan
- identify building(s) to be removed on the site plan
- estimated completion date of demolition
- if adjacent to a public access/thoroughfare, indicate how the public will be protected from the demolition process

P.S.D.S. APPLICATION REQUIREMENT CHECKLIST

Septic System

Application Page ensure:

- all signatures are included
- all mailing addresses, including postal codes are complete
- type of system being installed is indicated
- installers certification number is indicated, (contractor permit applications, only)
- tank size is indicated
- number of bedrooms is indicated

Site Diagram ensure:

- water source (well or cistern) is located
- any water course (named body of water) is indicated
- building being served is indicated
- tank and system (field/mound/at-grade/open discharge/etc.) location is shown
- set back distances are indicated
- depth of water table _____
- size of property _____
- GPS coordinates for well, benchmark, buildings and test pits

Summary Design Report

- ensure summary design report is included and completed for type of system being applied for

Soils Profile Log Form

- ensure at least **two** completed soils profile log forms are included (only one required for open discharge)

Soils Laboratory Analysis Report

- ensure at least **two** soil analysis reports are included (only one required for open discharge)

Worksheets (for all systems)

- ensure worksheets are included for all systems (pressure distribution, gravity, mound, etc.)
- B66 certificate for tank
- alarm information
- filter information

The above is the minimum required information for obtaining a private sewage system permit.

A list of private sewage certified contractors list can be found at
http://www.municipalaffairs.alberta.ca/CP_PrivateSewageContractorList.cfm.

PERMIT APPLICATION REQUIREMENTS FOR AT GRADE, SEPTIC FIELDS, TREATMENT MOUNDS AND OPEN DISCHARGE

The Alberta Private Sewage Standard of Practice (SOP) lays out the requirements for obtaining a permit for the installation of a private sewage system within the Province of Alberta.

1. A fully completed PSDS permit application page. Include the complete mailing address, postal code and signature of installer. In the case of a homeowner permit, the homeowner's signature is required. Include the legal land description, subdivision name, gate number and any special directions or maps to the installation site. This information will aid in finding the location for inspection purposes.
2. Properly dimensioned site diagram showing location of:
 - a) all buildings, driveways, utility right of ways
 - b) location of septic tank, treatment plant, dose tank
 - c) location of water source (well or buried cistern)
 - d) required setback distances, either dimensioned or listed on plan
 - e) any water courses (see minimum setbacks)
 - f) show all test hole locations by test hole number on diagram
3. You must excavate a minimum of two test holes (one for open discharge) just outside the area where you intend to install the field. Fill in one Soil Profile Log Form for each test hole describing the various layers of soil. See the Soils Profile Log Form Guide to aid you in this process. The test hole depth is required to ensure that you can obtain a 5 foot vertical separation (3 feet below mound) from the water table. If the hole partially fills with groundwater (not rain), then the location is unsuitable. Although 2 test holes are required, you can dig as many test holes as necessary to find the most suitable treatment location. Test hole depth for at grade is 6.5 feet, field 9 feet, mound 6.5 feet and open discharge 6 feet.
4. At each test hole you must take a sample of the soil. In a field system the depth of the trenches will be no deeper than 2 feet. As well, take samples from a depth of 3 to 5 feet. For a mound, at grade or open discharge, obtain a sample from the 2 to 3 foot depth. Gather and place approximately a litre of soil into a large sized heavy duty freezer bag. Using a felt pen, write your name, the date, the depth from which the sample was taken and the number of the test hole. This sample must be taken to a certified soil lab.

The following labs process soil samples for this purpose. Please check your local listings for companies in your area.

- a) Exova Labs, 7217 Roper Road, Edmonton, 780 438 5522
 - b) Caro Analytical, 17225 109 Avenue, Edmonton, 780 489 9100
 - c) KaizenLabs, 18104 102 Avenue, Edmonton, 780 451 4797
5. A completed Summary Design Report. A fill in the blanks Summary Design Report is included with the PSDS application form. Complete all parts that pertain to the type of system you are installing. For sewage holding tanks, use the Sewage Holding Tank application.
 6. A completed set of primary distribution, pressure distribution, mound or at grade work sheets are available on our web site.

EDSON

Phone: 780 723 4923
Fax: 780 723 3991

EDMONTON

Phone: 780 454 5048
Fax: 780 454 5222

COLD LAKE

Phone: 780 594 4301
Fax: 780 594 3720

-
7. Once you have received your laboratory soils analysis, submit your signed, completed application including a copy of the laboratory soil report, two soils profile log forms, the properly dimensioned site plan, the completed summary design report, the completed pressure distribution work sheets and a completed credit card agreement to our office.

Only after all of the above required information has been received, reviewed and found to be complete and compliant to the SOP, a permit will be issued and your work may commence.

MINIMUM SETBACKS FOR PRIVATE SEWAGE SYSTEMS

When choosing a treatment or discharge site, look for higher, dryer areas. Stay away from low or swamp areas to avoid effluent ponding or premature treatment system failure.

Septic Systems	Property Lines	Water Source*	Building**	Septic Tank	Basement	Water Course***
Holding or Septic Tank	1m 3.25 ft	10m 33 ft	1m 3.25 ft		1m 3.25 ft	10m 933 ft
Treatment Mound	3m 10 ft	15m 50 ft	10m 33 ft	3m 10 ft	10m 33 ft	15m 50 ft
Treatment Field	1.5m 5 ft	15m 50 ft	10m 33 ft	5m 17 ft	10m 33 ft	15m 33 ft
Open Discharge	90m 300 ft	50m 165 ft	45m 150 ft		45m 150 ft	45m 150 ft
Lagoons	30m 100 ft	100m 330 ft	45m 150 ft		45m 150 ft	90m 300 ft
Packaged Sewage Treatment Plants	6m 20 ft	10m 33 ft	1m 3.25 ft		1m 3.25 ft	10m 33 ft
At Grade 0-1% Slope	3m 10 ft	15m 50 ft	10m 33 ft	3m 10 ft	10m 33 ft	15m 50 ft
At Grade Over 1% Slope	6m 20 ft	15m 50 ft	10m 33 ft	3m 10 ft	10m 33 ft	15m 50 ft

* Water source is any well (in use or not), buried cistern, dugout, stream, etc. that provides water for human or animal consumption.

** Farm structures are not to be considered as building for PSDS purposes, however they need to be shown on the site diagram. Indicate the location and use of all structures.

*** To be considered a water course, there must be a discernible shoreline with an absence of vegetation between opposite shorelines. If watercourse is a river, lake or creek that has a name that appears on a map, the setback must be 90m or 300 feet.

For all systems, when preparing a site diagram, indicate the actual distance setbacks of all of the above mentioned categories that pertain to the site, ensuring the setbacks are appropriate for the system being installed and the location of each is marked on the diagram. Show other site features such as driveways, parking areas, other structures, vegetable gardens, rock outcroppings, forested areas, low or swampy areas, the direction and grade of the slope near tank or plant location or the treatment or discharge site.

AFTER THE PERMIT IS ISSUED

Once the permit is issued the permit holder must:

- a) comply with the terms and conditions of the permit. Please ensure you closely review your conditions of approval when you your permit and contact your SCO if you have questions,
- b) undertake the construction, process or activity in accordance with the Act and applicable codes and standards,
- c) notify the permit issuer if:
 - the permit holder does not intend to complete the undertaking,
 - there is a change in ownership from the owner as stated on the permit applications,
 - there are changes to submitted plans,
 - documentation is requested as a condition of your permit, ensure that a copy is sent to the SCO as soon as possible so the SCO can review them and inform you if there are any concerns.
- d) ensure that all plans and specifications required to apply for the permit are available at the construction site at all reasonable times for inspection by a Safety Codes Officer and
- e) ensure that a permit for the building discipline is posted, or otherwise identified, at the construction site.

Please inform us of your intention to start work, of any delays, changes, stoppages of work or an inability to complete the work.

Changes to the work in type, size and value has an impact on a permit. Unapproved changes to permitted work can result in cancellation of a permit or result in costly delays and repairs.

It is best to inform your Safety Codes Officer and issuing agency when there is a change. Most often it is a simple matter of changing the records on file.

If you change your address and/or phone number please include us on your notification list.

A permit expires if the project to which it applies if work is:

- a) not commenced within 90 days from the date of issue of the permit,
- b) suspended or abandoned for a period of 120 days, or,
- c) in respect of a seasonal use residence and the undertaking is suspended or abandoned for a period of 240 days after the undertaking is started.

When the term of the permit has not expired, a permit issuer may, in writing, and on the request of the permit holder, extend the permit for an additional fixed period of time that the permit issuer considers appropriate.

INSPECTIONS

Most municipal Quality Management Plans require that work is started within 90 days of a permit being issued. For Private Sewage Disposal Systems this requirement is within 30 days. If you do not call for inspection within this timeline, a SCO will come to your site to see if the work has started.

A final inspection is to be called for as required by the Quality Management Plan. This normally is a 6 months to 1 year timeframe that is identified on your plan review for the project. If you are unsure what this timeframe is please contact your SCO to find out. If your work is not going to be ready for final inspection in the timeframe that is identified in the Quality Management Plan, you can request an extension from your SCO in writing.

Booking an Inspection: Allow at least two working days (48 hours) notice for an inspection to take place. The applicant of an issued permit can request an inspection by phone, email, fax or online at www.inspectionsgroup.com. It is imperative that you call for required inspections when the work is ready. Failure to call for inspection may mean uncovering work that is completed to allow the SCO to inspect work that is concealed.

Inspection requests require the following information:

- Permit applicant contact name and phone number
- Permit number
- Project location / address (civic or legal)
- Directions to project location
- Stage of inspection

INSPECTION STAGES BY PERMIT TYPE

BUILDING PERMITS

NEW HOUSES	COMPLETION REQUIREMENTS
Foundation before backfilling:	<ul style="list-style-type: none"> • Footings and walls poured with forms removed • Weeping tile in place • Washed rock and damp proofing in place
Framing before drywall and insulation:	<ul style="list-style-type: none"> • Framing of walls, floors and roof complete • Foundation backfilled • Exterior doors and windows installed • Outside sheathing • Manufactured engineered floor layout • Truss layout and roof bracing details on site
Final prior to occupancy within 365 days of permit issuance:	<ul style="list-style-type: none"> • Handrails in place and guards complete • Heating/ventilation system installed and ductwork complete • Smoke alarms and carbon monoxide detectors installed • All items from previous inspection reports or plan examination complete

EDSON

Phone: 780 723 4923
Fax: 780 723 3991

EDMONTON

Phone: 780 454 5048
Fax: 780 454 5222

COLD LAKE

Phone: 780 594 4301
Fax: 780 594 3720

AN ADDITION TO A HOUSE

Framing prior to drywall:	<ul style="list-style-type: none"> • Framing of walls, floors and roof complete • Foundation backfilled • Exterior doors and windows installed • Outside sheathing • Engineered floor and roof truss layouts onsite
Final prior to occupancy:	<ul style="list-style-type: none"> • Similar to New House final. Some items may not apply

MANUFACTURED, RTM MODULAR OR RELOCATED HOME

Foundation before backfilling: (only when a full basement is included)	<ul style="list-style-type: none"> • The same as a new house foundation inspection
Final before moving in:	<ul style="list-style-type: none"> • All work is complete

ACCESSORY BUILDINGS (GARAGES, SHOPS)

Framing prior to drywall:	<ul style="list-style-type: none"> • Framing of walls, floors and roof complete
Final for Buildings valued over \$20K:	<ul style="list-style-type: none"> • All work is complete

DECKS, SHEDS, HOTTUBS OR POOLS

Final before using:	<ul style="list-style-type: none"> • All work is complete
---------------------	--

WOODSTOVES AND WOOD FIREPLACES

Rough-in (for built in units):	<ul style="list-style-type: none"> • The unit is in place, the clearances to combustibles and connection of various parts are open to view
Final before using:	<ul style="list-style-type: none"> • All work is complete, finishes are in place hearth and other surface protectors are in place • Carbon Monoxide alarm has been installed

TRADE PERMITS

ELECTRICAL PERMITS

Rough in prior to drywall	<ul style="list-style-type: none"> • Main service installed • All wire and boxes installed and visible • Bonding and grounding complete
Final prior to occupancy within 365 days of permit issuance:	<ul style="list-style-type: none"> • All items from previous inspection reports complete • Panel labeled • Smoke alarms installed • All load devices and switches installed and operational

GAS PERMITS

Final prior to occupancy within 365 days of permit issuance:	<ul style="list-style-type: none"> • All gas piping installed • Pressure test complete • Gas meter installed • All fixtures installed, vented and operational
--	---

PLUMBING PERMITS

Rough in prior to covering	<ul style="list-style-type: none"> • All drain or sewer lines installed • All water lines installed • All vent stacks installed
Final prior to occupancy within 365 days of permit issuance:	<ul style="list-style-type: none"> • All items from previous inspection reports complete • All fixtures installed and operational

PRIVATE SEWAGE DISPOSAL SYSTEM PERMITS

Rough in prior to being covered:	<ul style="list-style-type: none"> • Majority of system installed with a portion left open for inspection
----------------------------------	--

COMPLIANCE

AFTER THE INSPECTION – ACHIEVING COMPLIANCE

You have followed all the rules and called for all the inspections. Now what?

Ideally you will have passed your inspection. Whether it is under a Building, Plumbing, Gas, Electrical or P.S.D.S. permit, you want compliance. You want and deserve assurance that all the work you have done or paid for is in compliance with all applicable codes and regulations. As previously stated, every permit requires at least one inspection and maybe more. There is a possibility that an inspection will uncover a deficiency with code requirements.

Compliant

If the inspections are compliant, the owner of the property on which the work took place will receive a Permit Services Report (PSR). This is a required document that states the work, (within the limits of the specific permit), meets the intent of The Safety Codes Act and applicable code. A PSR is not a guarantee. It is a statement that inspections were carried out and those points that were inspected are in compliance.

Non Compliant

If the inspection is not 100% compliant, the inspection report requires that you repair, re-do or complete something. Now what? If you receive an inspection report that requires an action on your part, the first thing to do is ensure you understand what needs to be corrected, then plan what you will do to correct the deficiencies.

Let your inspector know when and how you will be correcting a deficiency. In some cases a re-inspection will be required; while in others a written verification will be acceptable. The worst thing to do is to ignore or forget to do something with a deficient inspection report. As an inspection agency, it is our purpose to work with you to achieve full compliance with your permits. We will work with you after a final inspection and maintain contact with you through the process. Your inspector is ready to discuss all matters with you and provide all the guidance he or she can.

When contact and co-operation with us has not been maintained, we have to continue to proceed with the permit file to bring it to a conclusion.

BEDROOM WINDOW EGRESS

Bedroom windows must be sized so that they can be used as a direction of escape in case of fire. Each bedroom must have a window that opens from the inside without the use of tools or special knowledge and has an unobstructed area when open of at least 0.35 m² or 3.75 sq. ft. (minimum dimension of opening, (width or height), allowed is 380 mm or 15") (Division B Article 9.7.1.2).

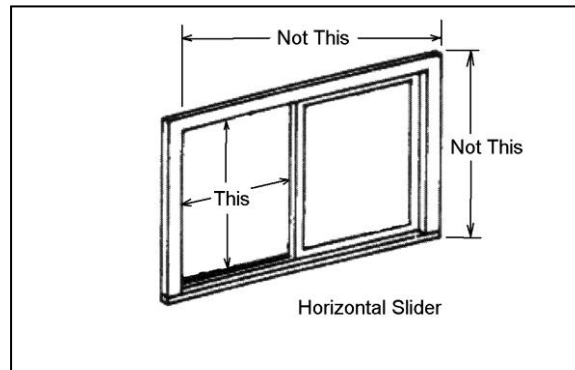
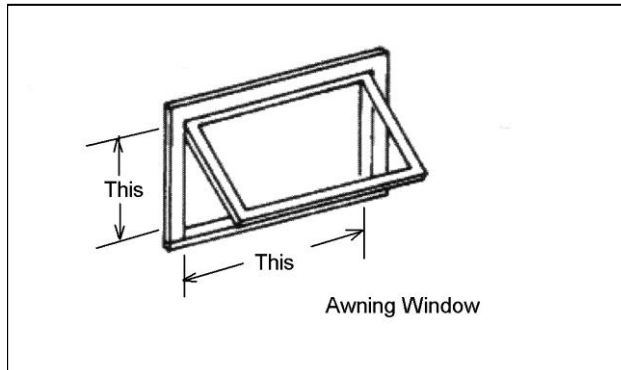

The critical area of a bedroom window is the open area that is free and clear of obstruction when open fully.

If a bedroom window is fitted with security bars, the bars must be openable from the inside without the use of any tool or special knowledge. (Division B Article 9.7.1.2).

Where a bedroom window opens into a window well, a clearance of not less than 760 mm must be provided in front of the window. (Division B Article 9.7.1.3.).

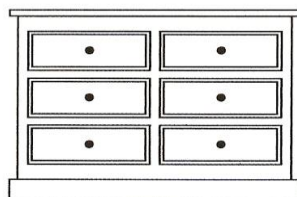
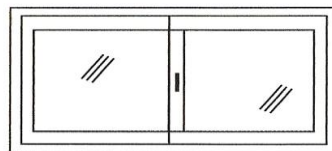

There is no minimum or maximum height requirement stated in the Alberta Building Code for bedroom windows in a basement development. It is recommended to have furniture built in to aid smaller children to access an escape route through a window in an emergency.

TYPICAL ENTRANCE LANDING WITH GUARD RAILS AND STAIR

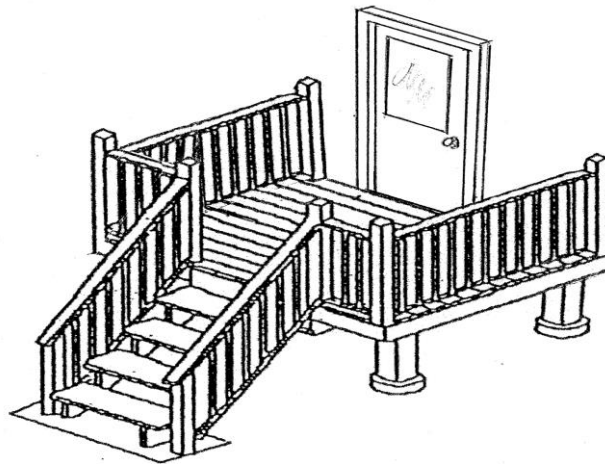

STAIR CONSTRUCTION:

Treads and risers shall have uniform rise and run in any one flight with a maximum tolerance of 6mm. (Division B Article 9.8.4.1.Unif. Treads and Risers). The landing should be approximately 1500mm (5') wide and 1200mm (4') in depth.

The stairs shall

- have a minimum run of 210 mm (8 1/4") and a maximum rise of 200 mm (7.87 "), and a minimum tread width of 250 mm (9.84"), and uniform rise/run throughout any one flight
- be provided with a handrail if more than three risers

WHEEL CHAIR RAMP

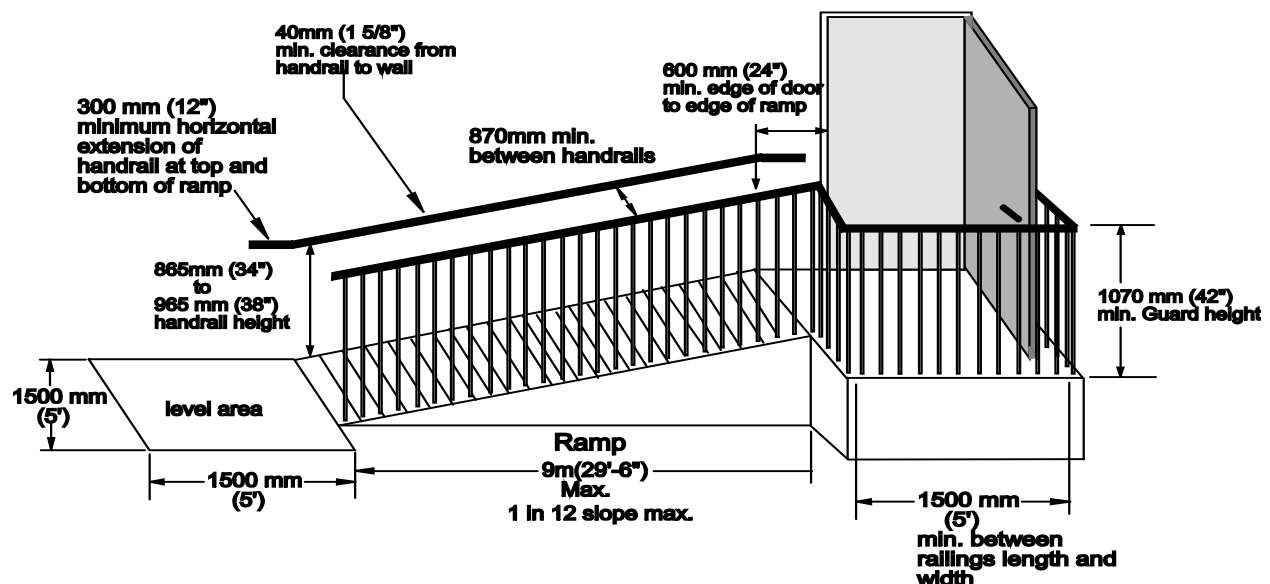

TYPICAL GUARD CONSTRUCTION

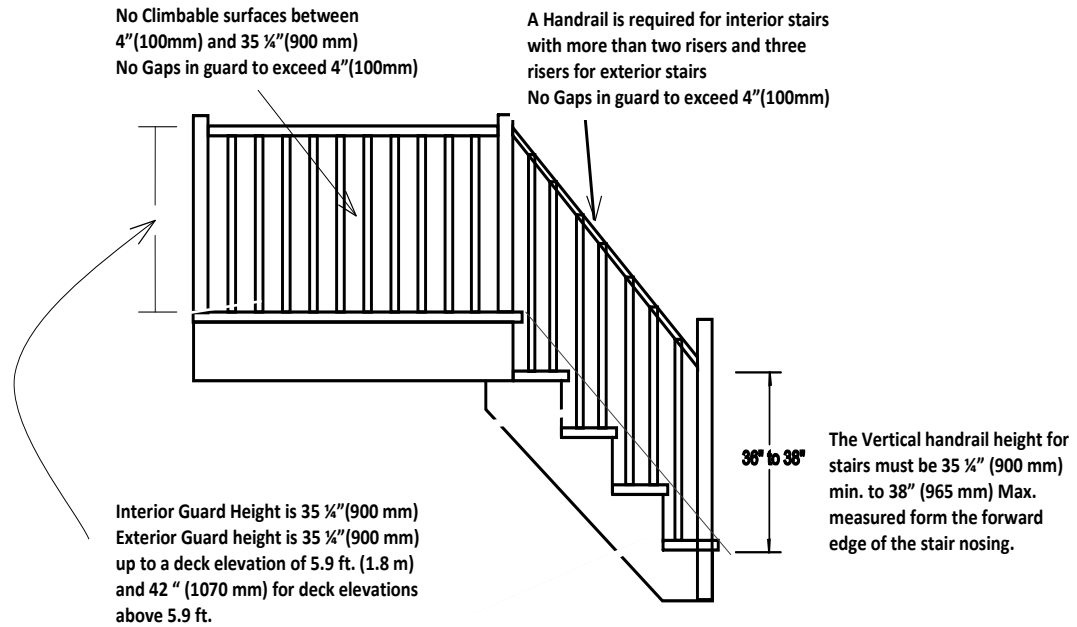

TYPICAL ARRANGEMENT FOR A WOODSTOVE INSTALLATION

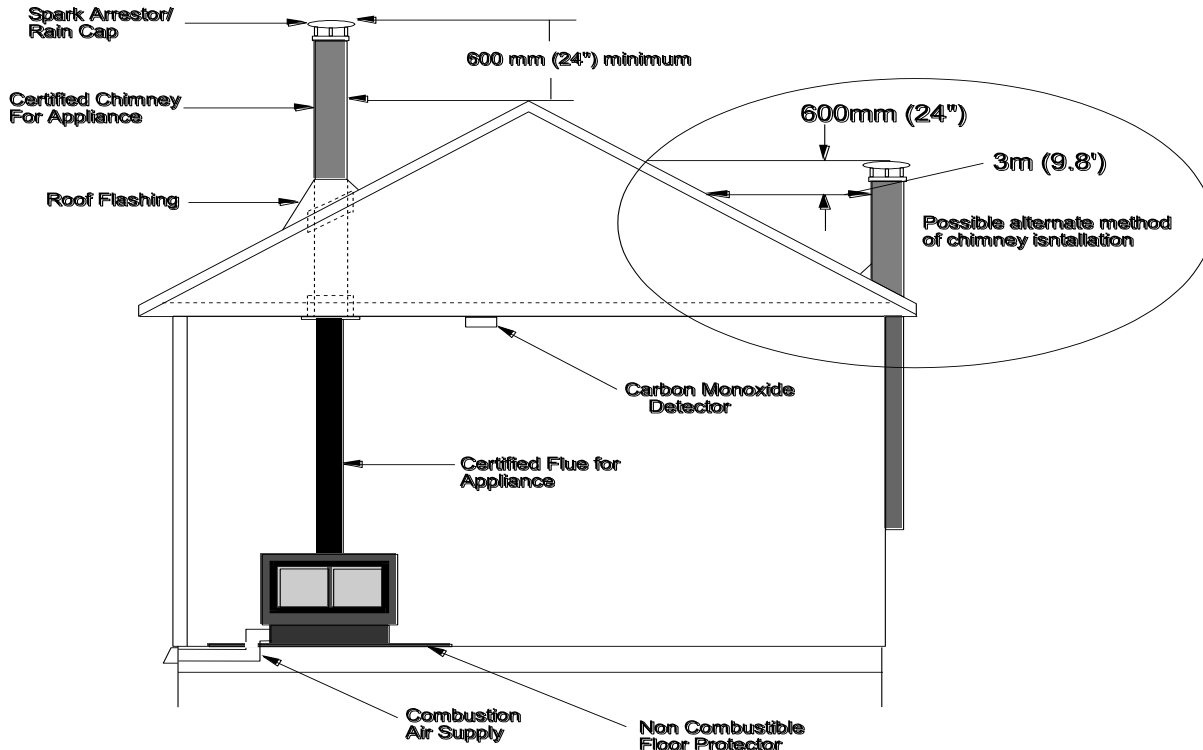

UNCOVERED DECK INFORMATION

(You may complete this form and attach it to your Building Permit Application)

TYPICAL DECK CONSTRUCTION (Deck attached to house. No roof cover)

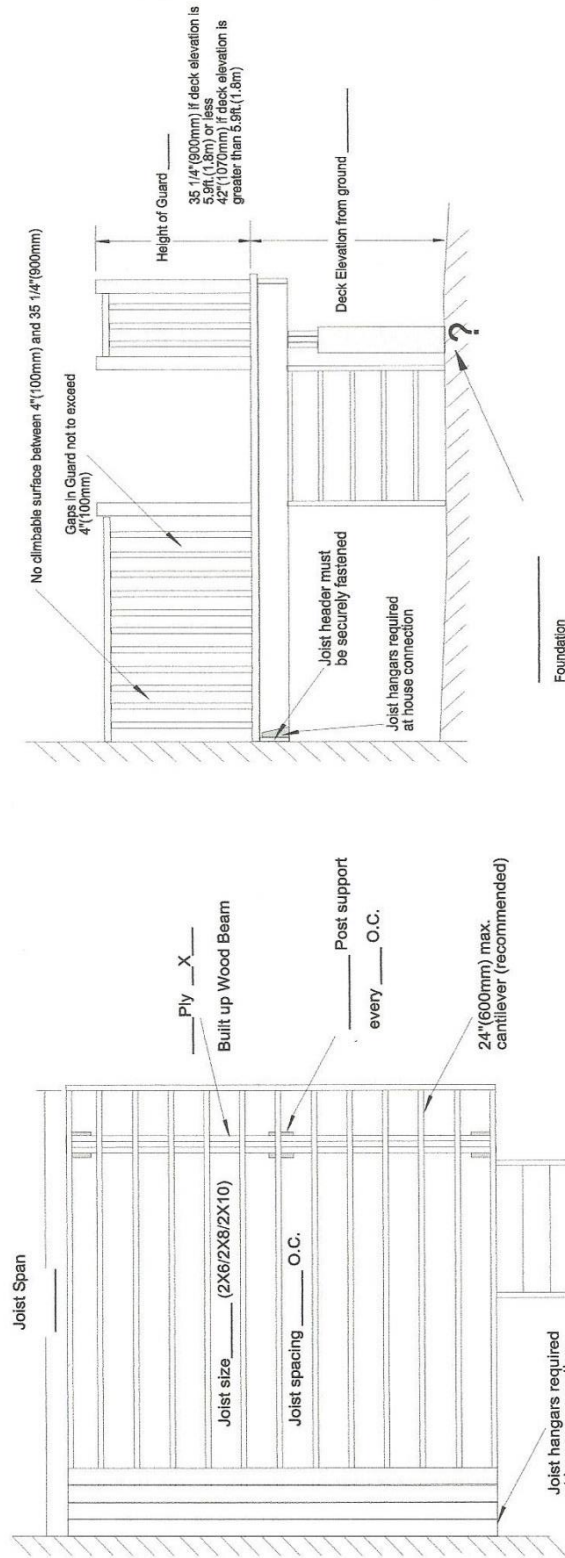

Typical Framing Material, Spacing and Spans		24" O.C.
Joists # 1 & 2 S.P.F.	16: O.C.	8" 2"
	9' 4"	10' 9"
	12' 4"	13' 9"
Post Spacing	Joist Span 1 & 2 S.P.F.	Beam 1 & 2 S.P.F.
	8'	2 ply 2" x 8"
6' O.C.	10'	2 ply 2" x 8"
	12'	2 ply 2" x 8"
	8'	2 ply 2" x 10"
8' O.C.	10'	2 ply 2" x 10"
	12'	2 ply 2" x 10"

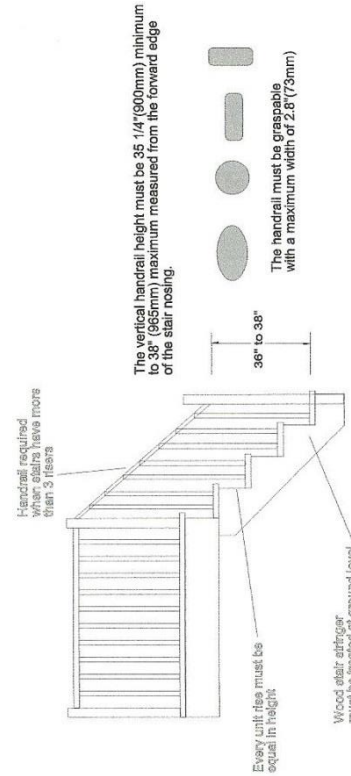

PRIVATE GARAGE INFORMATION

(Both pages to be fully completed and attached to the Building Permit Application)

Owner Name: _____

Address: _____ Postal Code: _____

Phone: _____ Fax: _____

Email address: _____

THE FOLLOWING INFORMATION IS REQUIRED TO OBTAIN A BUILDING PERMIT:

BUILDING SIZE: Length _____ X Width _____ X Wall Height _____

BUILDING FOUNDATION (check one)

- concrete slab on grade 55 square meters (592 sq. ft.) or less
- concrete slab on grade greater than 55 square meters (592 sq. ft.) (Engineered design and stamped drawing is required)
- concrete frost wall on concrete strip footing with minimum 4 foot depth
- concrete pile and grade beam (engineered design and stamped drawing is required)
- other _____

WALL CONSTRUCTION (complete information or circle as required)

- 2 x _____ wall studs _____ inches on center
- 2 x _____ double top plates
- 2 x _____ treated bottom plate
- 1/2 inch anchor bolts maximum 8 feet apart
- _____ windows
- _____ man door(s) (minimum one required)
- 2 2 x _____ headers over windows and man door(s)
- overhead door header type _____ size _____
- wall sheathing: 3/8" 7/16" 1/2" O.S.B spruce plywood other _____
- I.C.F. Wall Construction _____ thickness _____ height
- siding: vinyl stucco metal other _____
- electrical lighting: interior exterior

ROOF CONSTRUCTION

- engineered trusses _____ inches on center
- site framed roof _____
- roof covering: asphalt shingles metal other _____
- roof Sheathing: 3/8" 7/16" 1/2" O.S.B spruce plywood other _____

EDSON

Phone: 780 723 4923
Fax: 780 723 3991

EDMONTON

Phone: 780 454 5048
Fax: 780 454 5222

COLD LAKE

Phone: 780 594 4301
Fax: 780 594 3720

ACCESSORY BUILDING PLAN SHEET

GARAGE, SHED AND ACCESSORY BUILDING PLAN SHEET

SITE PLAN

INDICATE THE PLANNED POSITION OF THE NEW BUILDING ON THE PROPERTY WITH DIMENSIONS TO THE PROPERTY LINE. INCLUDE THE LOCATION OF ALL OTHER BUILDINGS. INDICATE THE NORTH DIRECTION



FLOOR PLAN

RECORD THE LENGTH AND WIDTH OF THE BUILDING. DIMENSION THE SIZE AND LOCATION OF ALL WINDOWS AND DOORS. SHOW ANY INTERIOR IMPROVEMENTS SUCH AS MEZZANINES, SECOND FLOORS AND INTERIOR ROOMS.

PLEASE INDICATE ON THE DIAGRAMS BELOW: THE FRONT BACK LEFT AND RIGHT SIDE OF THE BUILDING. ALL WINDOW AND DOORS WITH APPROXIMATE SIZES.

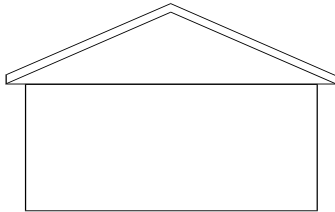

_____ VIEW

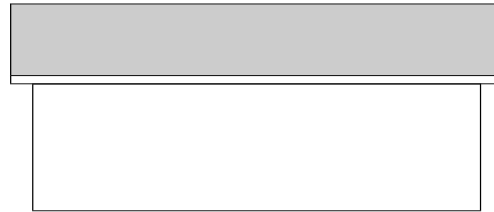

_____ VIEW

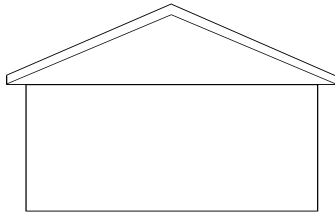

_____ VIEW

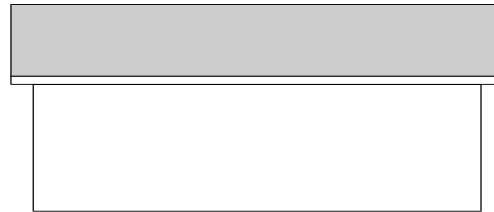

_____ VIEW

ACCESSORY BUILDING SECTION VIEW

GARAGE, SHED AND ACCESSORY BUILDING SECTION VIEW

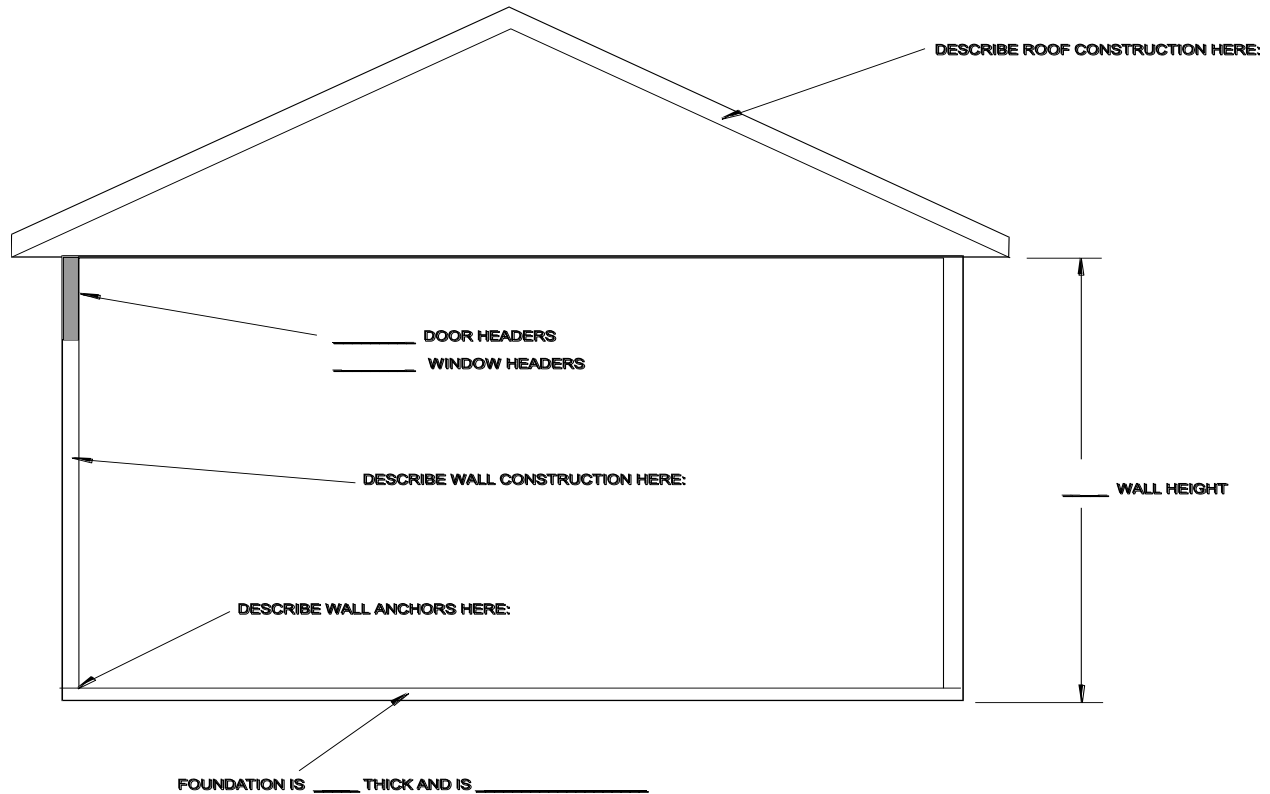

COMPLETE THIS DIAGRAM AS IT APPLIES TO YOUR CONSTRUCTION

1. DIMENSION THE WALL HEIGHT
2. INDICATE THE TYPE AND THICKNESS OF THE FOUNDATION
3. DESCRIBE THE BUILDING ANCHORS
4. IDENTIFY THE TYPE AND THE DIMENSIONS OF THE WINDOW AND DOOR HEADERS
5. COMPLETE THE ROOF SECTION SHOWING THE TRUSS WEBBING WITH ANY BRACING OR RAFTER CONSTRUCTION
6. INDICATE AND DESCRIBE PROVISION FOR ROOF VENTILATION, ANY INSULATION AND WALL FINISHES.

MANUFACTURED HOME INFORMATION SHEET

(both pages to be completed fully and attached to the Building Permit Application)

Owner Name: _____

The following information is required to obtain a building permit. The information required on lines one through four is provided by the manufacturer of the unit and is recorded on a label affixed to the home.

1. C.S.A. Label Number _____
2. A.M.A. Number _____
3. Serial Number _____
4. Year of Manufacture _____
5. Type of Foundation: Wood Blocking
 Concrete Piles (requires engineered drawings)
 Pier Foundation
 Steel Piles (requires engineered pile details)

Project Location: Part of Section _____ Township _____ Range _____ W. of _____ M. 6
Subdivision _____ Lot ____ Block _____ Plan _____
Municipal Address: _____

7. Size of Building: Length: _____ X Width: _____ = _____ Total sq. ft.

Please answer the following questions:

1. Is this home brand new? Y N
2. Is this home built on a steel frame? Y N
3. Is this home being relocated from somewhere other than a factory?

4. This home is being relocated for the _____ time.
5. Has this home had any renovations or additions since leaving the factory?

The setup of this home includes two 4'x6' landings with stairs and railings. Decks, Additions and Woodstoves require the submission of separate plans and details.

RELOCATED MANUFACTURED HOME



REAR VIEW

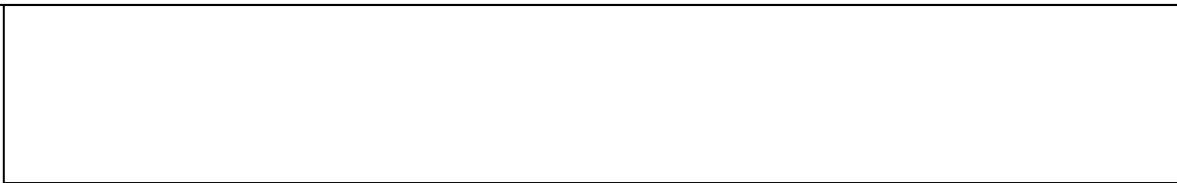

FRONT VIEW

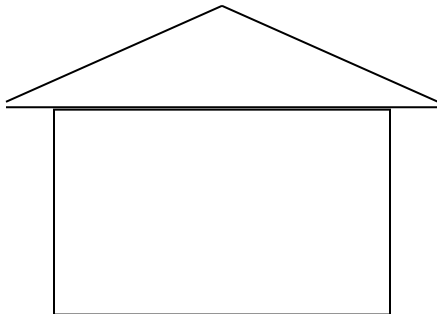

LEFT VIEW

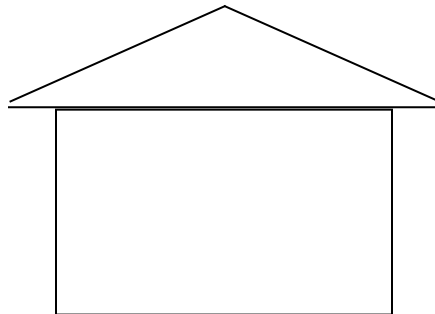

RIGHT VIEW

BUILDING L. _____

BUILDING W. _____

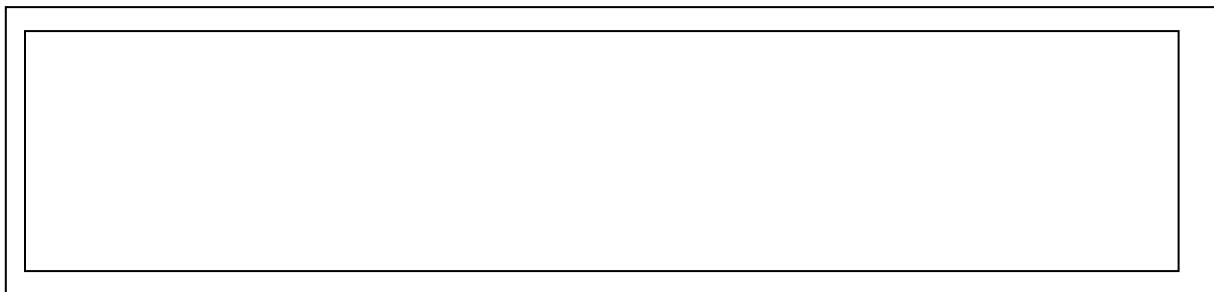

PLAN VIEW

Please complete the views on this page as accurately as possible and indicate the following:

- 1) the approximate sizes and locations of all rooms
- 2) the approximate sizes and location of all windows and doors
- 3) the location of all carbon monoxide alarms and smoke alarm

BASIC BUILDING FOUNDATIONS

The examples illustrated on the following pages are not intended to be a complete list. They are examples of the most common foundations currently being used for residential construction and is for information only.



Poured Concrete Wall on a Strip Footing

This is by far the most common foundation for new home construction. Minimum widths and thicknesses can vary so be sure to consult your local Building Safety Codes Officer if you are unsure about dimensions. In this example there will be a full basement on the opposite side of the wall. You can see in this picture a foundation that has been dampproofed. The perimeter weeping tile is in place awaiting coverage by six inches (150 mm) of clear stone. This foundation does not require professional engineering.



Frost Wall Foundation

This foundation is generally used when either a crawl space will be used under a building or both sides of the wall will be backfilled. Most often it is constructed from poured concrete. It is called a frost wall because it is meant to extend a minimum depth into the ground to be below expected frost penetration. This foundation does not require professional engineering.



Preserved Wood Foundation

This foundation has its walls constructed from below grade certified treated wood. It can have either PWF footings and floor or poured concrete footings and floor. Most of these foundations are built from engineered drawings. Care must be taken to ensure that the wood used in this construction is not confused with treated wood meant for above grade work like decks.



Pier Foundation

These foundations are generally constructed from poured concrete. Under normal residential use they would not require an engineered design. A pier foundation is comprised of a column and a base. The width of the column must be at least one third of its height. The base would be a minimum of 4" (100mm) thick extending beyond the column base the same distance. Typical uses for this foundation are covered porches, small additions or buildings.



Pile Foundation

A pile foundation is most often a series of cylindrical holes drilled into the ground and filled with concrete. Typical uses are decks and porches added to an existing building. Care must be taken here with the potential roof loads that may be placed on the pile. This foundation is not definitively described in The Alberta Building Code and will likely require a design stamped by a professional engineer before a permit may be issued.



Pile and Grade Beam Foundation

This foundation is constructed from poured concrete. It is comprised of steel reinforced piles spanned by a steel reinforced beam. The intended use of this foundation is where the bearing surface of the ground is not adequate, (too soft) to support footings. The piles are placed deep enough to find firm support and the grade beam supports the building over the soft ground between the piles. The complexity of this foundation type requires that it be designed and the plans stamped by a professional engineer.



Poured Concrete Slab Foundation

This foundation is made from poured concrete resting on the surface of the ground. The Alberta Building Code limits its size to 55 sq. m. or 592 sq. ft. This foundation type is permitted for single storey detached garages with no masonry veneer. It is not intended for houses, cabins or tall wall construction. Slabs that exceed the maximum size allowed or are used for buildings other than vehicle parking will require the slab plans to be designed and stamped by a professional engineer.

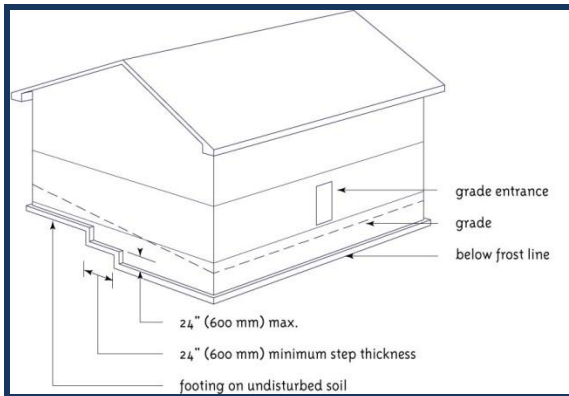

Step Footing Foundation

This foundation is made from poured concrete resting on the surface of the ground with changes in elevation to maintain the strip footings a minimum of 4' below finished grade. The maximum height/rise of one step is 600mm/2' and the minimum horizontal measure/run is 600mm/2'. Exceeding the maximum rise or minimum run will result in the construction requiring review by a professional engineer.



ICF Foundation

This foundation is made from poured concrete that has a permanent insulating form. The form is made of a foamed plastic. This product is a good insulator and helps keep basements warm. However foamed plastics are exceptionally toxic when exposed to fire and building code requires that the interior surfaces be covered with a thermal barrier. This can be a drywall panel that is tightly fitted.

BUILDING PERMIT APPLICATION GUIDELINE

Section 9.36.
Permit
Application
Information
Required on
Submitted Drawings



Section 9.36 Building Permit Application Guideline

Section 9.36 of the Alberta Building Code came into force Nov 1, 2016. The change introduced efficiency requirements for appliances in buildings, as well as changing how insulation values are measured. Insulation used to be measured based on the performance of only the nominal value of one component...the actual insulation. Now a wall/floor/roof/foundation are measured for their effective insulating value based on all materials in the assembly.

When applying for a building permit the submitted plans need to indicate, on **the cover page of the submitted drawings**, which method of compliance with Section 9.36 the applicant has chosen. Details on the three options are contained below.

Prescriptive Method

On your submitted drawings you need to clearly identify how each of the wall/floor/roof/foundation assemblies are going to be built and provide a summary calculation that shows what each of the wall/floor/roof/foundation assemblies has for an RSI value. This can be noted for each assembly on the section drawings through the building, listed as a specification on the drawings, or provided on separate documents attached to your permit application.

Required effective insulation values are available on information sheets for each climactic zone.

If you don't have your window and door installation schedules at the time of permit application, this will be a condition of your permit that will need to be provided once they become available. You can indicate on your submitted plans what the intended energy value for each door and window energy value will be [see the information sheets for code required maximum values].

Trade-Off Method

Trade-Off applications are an advanced method of prescriptive compliance where some element(s) are allowed to be reduced in efficiency when traded with other higher efficiency components. The end result must be equal or greater in efficiency. There are also limitations on this approach in the Alberta Building Code Division B Article. 9.36.2.11. which must be strictly followed.

Trade-Off applications need to provide a clear set of calculations that show the proposed building conforming to the prescriptive requirements and a clear comparison with the component(s) that are being traded or altered due to traded components. If the calculations are unclear, you will be requested to clarify the submitted information.

Performance Method

This approach requires the services of a design professional to evaluate your proposed project via a computer energy model. This approach requires 100% conformance to the professional's design. Deviations will require re-submission of the design with changes made to reflect what has been changed on site.

The complete energy model package is required to be submitted with the drawings for the permit application when this method is selected. The documentation package must clearly identify the designer.

***All information normally required on a permit application is still required to evaluate the proposed project for conformance with applicable codes and regulations. This document is only to assist with Section 9.36 information portion of those requirements.

EDSON

Phone: 780 723 4923
Fax: 780 723 3991

EDMONTON

Phone: 780 454 5048
Fax: 780 454 5222

COLD LAKE

Phone: 780 594 4301
Fax: 780 594 3720

PRESCRIPTIVE REQUIREMENTS GENERAL INFORMATION SUMMARY ZONE 7A

ABC 2016 9.36.

Revision 1

ZONE

theinspectionsgroupinc.

7A 9.36 Prescriptive Requirements General Information Summary

Assembly	Air intake/outlets shall have dampers or an HRV.	
	Effect. Insul. Value (without HRV)	Effect. Insul. Value (with HRV)
Wall (incl. att. garage walls)	R-17.5 (RSI 3.08)	R 16.8 (RSI 2.97)
Attic Ceiling	R-59 (RSI 10.43)	R 49.2 (RSI 8.67)
Cathedral Ceiling	R-28.5 (RSI 5.02)	R 28.5 (RSI 5.02)
Floor over Unheated Space	R-28.5 (RSI 5.02)	R 28.5 (RSI 5.02)
Floor over Unheated Garage	R 28.5 (RSI 5.02)	R-28.5 (RSI 5.02)
Slab on Grade	R 21.1 (RSI 3.72)	R 16.1 (RSI 2.84)
Foundation Walls	R 19.6 (RSI 3.46)	R 16.93 (RSI 2.98)

HVAC	Efficiency Values
Gas Fired furnace	Min AFUE 92%
Gas Fired Water Heater	EF>0.67

Windows, Doors & Skylights	Transmittance / Insul. Values	Min. Energy Rating
<i>U values are MAXIMUMS</i>		
Windows & Doors	USI 1.6 (U 0.28)	25
Front Door	USI 2.6 (U 0.46)	25
Garage Mandoor	R 6.25 (RSI 1.1)	25
Skylights	USI 2.7 (U 0.48)	25

All values in diagram assume that there is NO HRV.

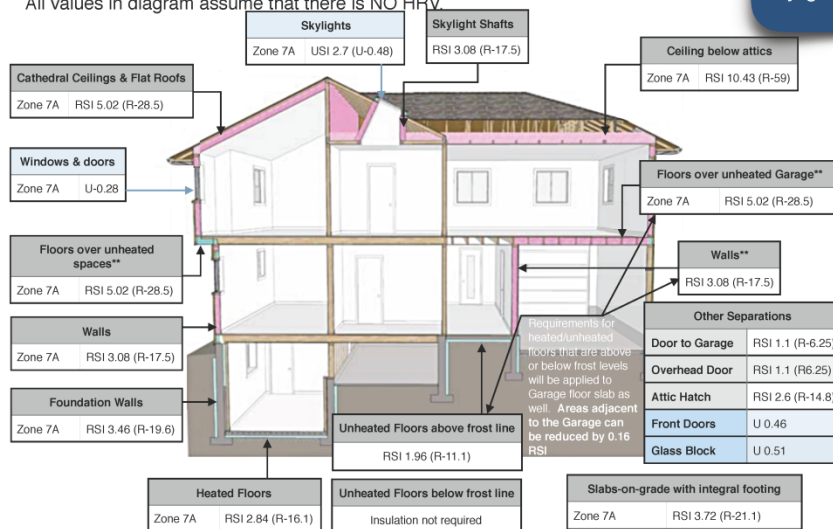

This document is designed to provide you with clarity on information required to be identified on the submitted plans for a building permit.

The required values are shown to clearly indicate what our plan reviewers will be looking/asking for on applications submitted as of Nov 1, 2016.

Your doors, windows/skylights need to meet the required U values shown. Your door/window supplier can provide you with the required information on the door/window schedules they provide. If this information is not provided at the time of application, it will be a condition of the permit.

**Requirements specific to effective insulation requirements for separation of conditioned from unconditioned space(s).

Wall assembly calculator:
<http://cwc.ca/resources/wall-thermal-design/>

Link will allow you to input what you are building and calculate if what you are planning will meet the noted requirements.

Additional Items of Note

- Attic insulation needs to reach required depth within 1.2m/4' of the outside wall.
- Hot & Cold water lines attached to the hot water tank both need to be insulated for 2m from the tank.
- If you choose automated dampers to control air inlet/exhaust, instead of an HRV, then these automatically controlled dampers must fail open.
- If you have ductwork, electrical panels, plumbing lines in an exterior wall you must have the full effective insulation achieved behind these elements as for the entire wall assembly.

PRESCRIPTIVE REQUIREMENTS GENERAL INFORMATION SUMMARY ZONE 7B

ABC 2016 9.36.

Revision 2

ZONE



7B

9.36 Prescriptive Requirements General Information Summary

Air intake/outlets shall have dampers or an HRV.

Assembly	Effect. Insul. Value (without HRV)	Effect. Insul. Value (with HRV)
Wall (incl. att. garage walls)	R-21.9 (RSI 3.85)	R 17.5 (RSI 3.08)
Attic Ceiling	R-59 (RSI 10.43)	R-59 (RSI 10.43)
Cathedral Ceiling	R-28.5 (RSI 5.02)	R 28.5 (RSI 5.02)
Floor over Unheated Space	R-28.5 (RSI 5.02)	R 28.5 (RSI 5.02)
Floor over Unheated Garage	R 28.5 (RSI 5.02)	R-28.5 (RSI 5.02)
Slab on Grade	R 21.1 (RSI 3.72)	R 16.1 (RSI 2.84)
Foundation Walls	R 19.6 (RSI 3.46)	R 16.93 (RSI 2.98)

HVAC	Efficiency Values
Gas Fired furnace	Min AFUE 92%
Gas Fired Water Heater	EF>0.67

Windows, Doors & Skylights	Transmittance / Insul. Values	Min. Energy Rating
<i>U values are MAXIMUMS</i>		
Windows & Doors	USI 1.4 (U 0.25)	29
Front Door	USI 2.6 (U 0.46)	29
Garage Mandoor	R 6.25 (RSI 1.1)	29
Skylights	USI 2.7 (U 0.48)	29

All values in diagram assume that there is NO HRV.

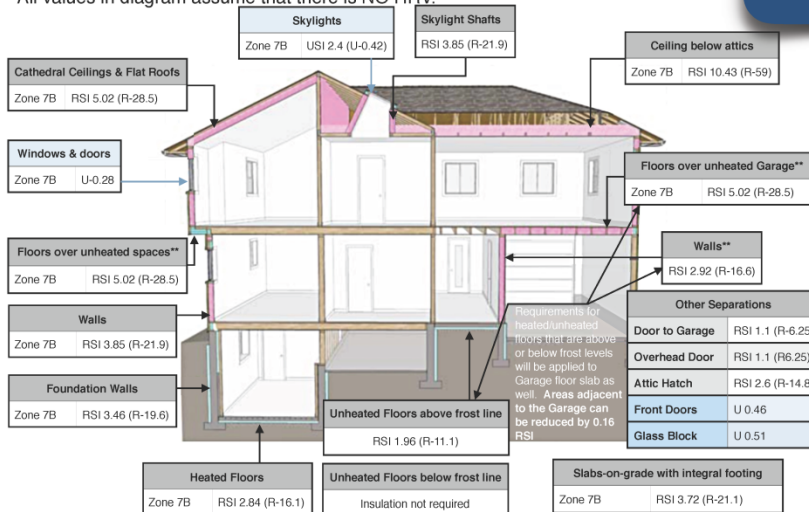

**Requirements specific to effective insulation requirements for separation of conditioned from unconditioned space(s).

Wall assembly calculator:
<http://cwc.ca/resources/wall-thermal-design/>

Link will allow you to input what you are building and calculate if what you are planning will meet the noted requirements.

This document is designed to provide you with clarity on information required to be identified on the submitted plans for a building permit.

The required values are shown to clearly indicate what our plan reviewers will be looking/asking for on applications submitted after Nov 1, 2016

Your doors, windows/skylights need to meet the required U values shown. Your door/window supplier can provide you with the required information on the door/window schedules they provide. If this information is not provided at the time of application, it will be a condition of the permit.

Additional Items of Note

- Attic insulation needs to reach required depth within 1.2m/4' of the outside wall.
- Hot & Cold water lines attached to the hot water tank both need to be insulated for 2m from the tank.
- If you choose automated dampers to control air inlet/exhaust, instead of an HRV, then these automatically controlled dampers must fail open.
- If you have ductwork, electrical panels, plumbing lines in an exterior wall you must have the full effective insulation achieved behind these elements as for the entire wall assembly.

PRESCRIPTIVE REQUIREMENTS FOUNDATION INFORMATION

ABC 2016 9.36.

ZONE

the **inspectionsgroup** inc.

7A/B

9.36 Prescriptive Requirements Foundation Information

Assembly	Effect. Insul. Value (without HRV)	Effect. Insul. Value (with HRV)
Unheated Floor BELOW frost	Uninsulated	Uninsulated
Unheated Floor ABOVE frost	R 11.13 (RSI 1.96)	R 11.13 (RSI 1.96)
Slab on Grade	R 21.1 (RSI 3.72)	R 16.1 (RSI 2.84)
Foundation Walls	R 19.6 (RSI 3.46)	R 16.93 (RSI 2.98)

Slab On Grade - Engineered Structural Slab

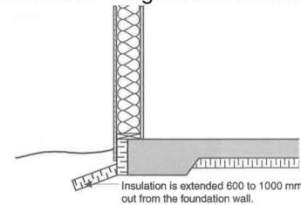

Length of extension as per eng. design.
***N/A to detached garage/accessory buildings not required to be heated.

Please note that the assemblies listed here are NOT the only code compliant options but are provided to assist you the applicant with meeting the requirements of the Alberta Building Code energy requirements. This document is not intended to address all elements of the energy code, but intended to provide information on requirements that are difficult to change if constructed incorrectly.

Samples of Compliant Foundation Assemblies

Foundation Example 1

Component	RSI
8" Concrete	0.08
Air Cavity - 1" / 25mm	0.18
2x6 Framing w/R20 batt @ 24" o/c	2.81
Rigid Foam - 1" / 25mm <small>Must be Continuous</small>	0.88
Gypsum Board - 12.7mm	0.08
Air Film	0.12
Effective RSI value for assembly	4.15

Foundation Example 2

Component	RSI
8" Concrete	0.08
Air Cavity - 1" / 25mm	0.18
2x4 Framing w/R14 batt @ 16" o/c	1.81
Rigid Foam - 2" / 50mm <small>Must be Continuous</small>	1.68
Gypsum Board - 12.7mm	0.08
Air Film	0.12
Effective RSI value for assembly	3.95

Foundation Example - ICF

Description	Continuous Material rating	Entire Assembly
6"/150mm ICF Form	3.52 (R-20)	RSI 3.58 [R.eff-20.33]
	3.73 (R-21.1)	RSI 3.79 [R.eff-21.52]

Floors ABOVE Frost Level

Clarification on insulation of unheated floors and insulation location requirements. (Div. B Art. 9.36.2.8. Alberta Building Code)

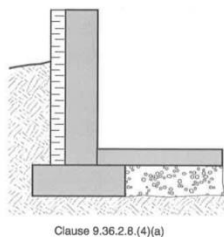

OR

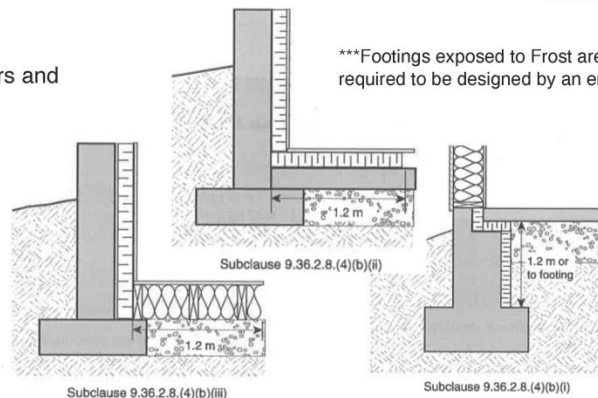

***Footings exposed to Frost are required to be designed by an engineer.

AIR BARRIER SYSTEM INFORMATION

9.36 Air Barrier System Information



For additional questions please contact us at info@inspectionsgroup.com

What is an Air Barrier System?

The Building Code defines it as the assembly installed to provide a continuous barrier to the movement of air.

Essentially the air barrier is used to control air flow in/out of your building through the outside walls/foundation/roof; creating a sealed envelope around your building. When this is done effectively it substantially improves the ability to control moisture and energy within your building.

Current construction practices use a single component, the poly on the inside of the wall to act as both a vapour barrier and as the air barrier. This approach uses one material to serve two functions.

So what is new about this?

Section 9.36 of the 2014 Alberta Building Code brought additional requirements that increase minimum levels of building performance.

The biggest change to the air barrier system is that now all joints are required to be sealed [which was there before] AND **structurally supported**. Depending on where you put the air barrier in the wall assembly, achieving this can add a significant amount of work. Current construction practice would now require supporting every joint at every light switch, electrical outlet and fixture. This will add a significant amount of solid blocking or require specialized electrical boxes with flanges and a gasket built into the boxes.

Exterior Air Barrier Approach

This approach separates the air barrier from the vapour barrier. By installing the air barrier on the exterior of the building, the walls of your project have significantly fewer penetrations that require sealing, you don't have all the sealing between floor joists on the interior and by virtue of the exterior sheathing, all joints are structurally supported. You only need to install and seal your air barrier according to the manufacturer's installation instructions for the material you have chosen; but not less of a lap than 2" at all joints.

By separating the air barrier and vapour barrier, the air barrier controls the air seal/envelope continuity and the vapour barrier prevents the accumulation of water vapour in your walls. This approach is an alternative to the traditional method of using the vapour barrier as the air barrier.

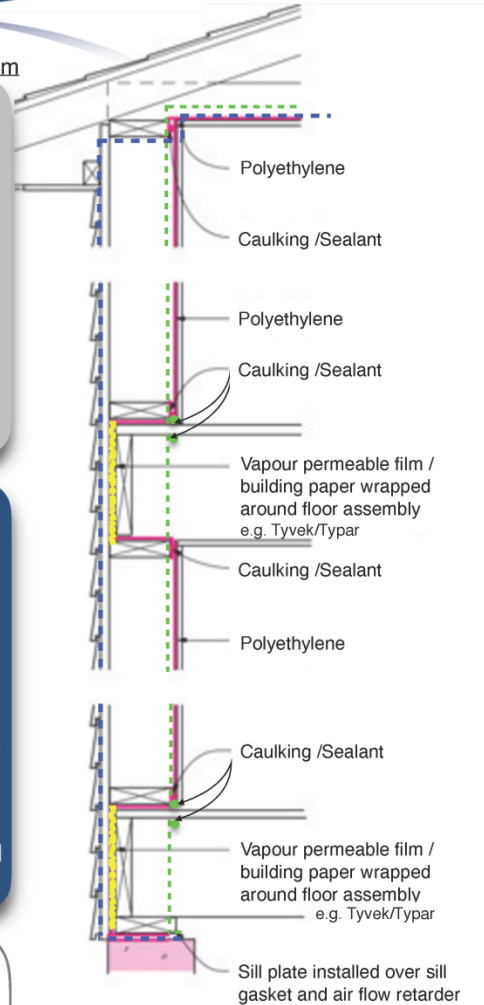

- Current Air Barrier/Vapour Barrier ■
- Combined Construction ■
- Alternative Air Barrier Construction ■
- Exterior Air Barrier Construction ■

Alternatively to sealing every joint in the air barrier system as required by prescriptive requirements you can blower door test your building to CAN/ULC-S742 or ASTM E2357. IF the blower door test meets the air changes per hour requirement this will also meet the Building Code requirements.

TRAP VENTING

Problem Trap Venting

This configuration is often seen when installers are attempting to gain headroom, by keeping trap above the bottom of floor joists. A vent would be required here.

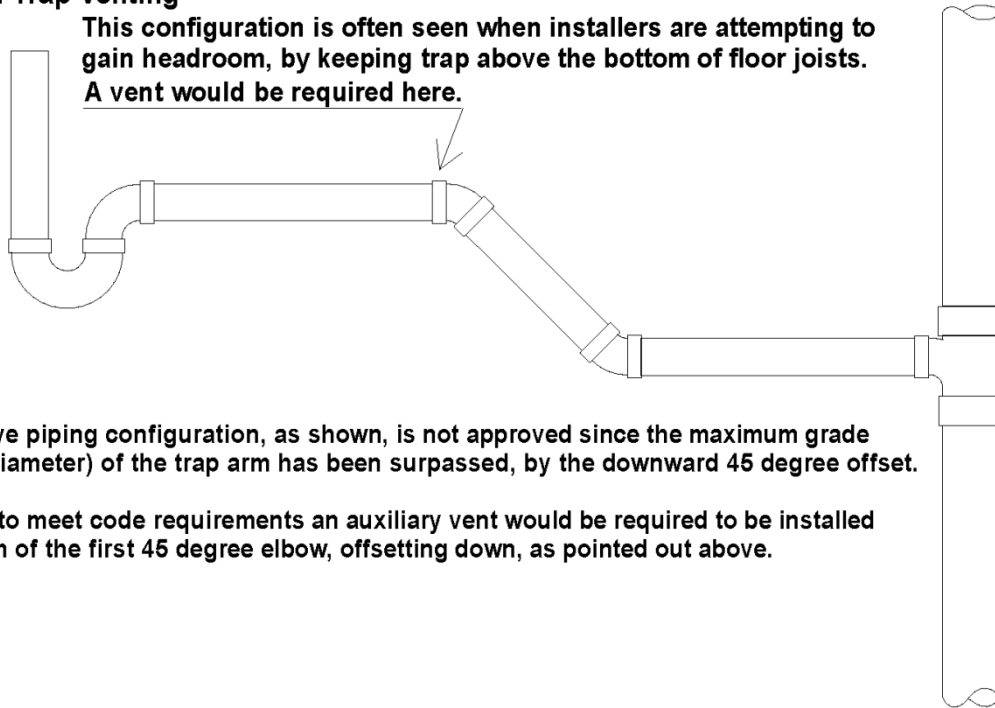

The above piping configuration, as shown, is not approved since the maximum grade (1 pipe diameter) of the trap arm has been surpassed, by the downward 45 degree offset.

In order to meet code requirements an auxiliary vent would be required to be installed upstream of the first 45 degree elbow, offsetting down, as pointed out above.

Approved Trap Venting.

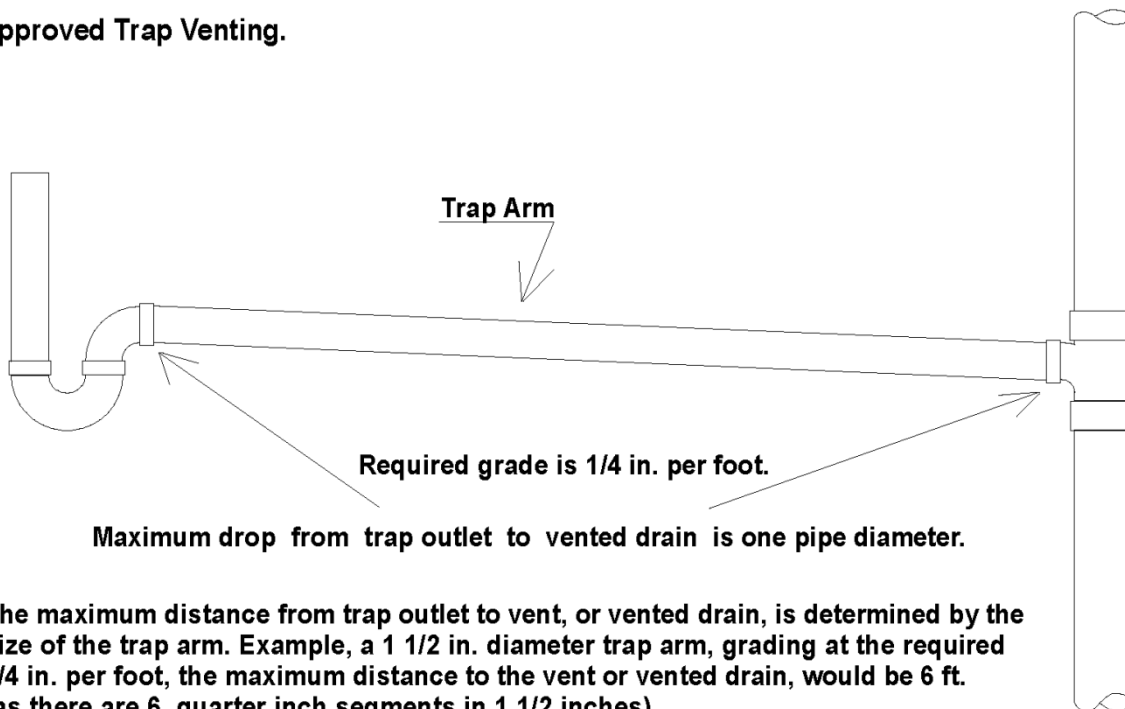

The maximum distance from trap outlet to vent, or vented drain, is determined by the size of the trap arm. Example, a 1 1/2 in. diameter trap arm, grading at the required 1/4 in. per foot, the maximum distance to the vent or vented drain, would be 6 ft. (as there are 6, quarter inch segments in 1 1/2 inches).

PLUMBING ROUGH IN

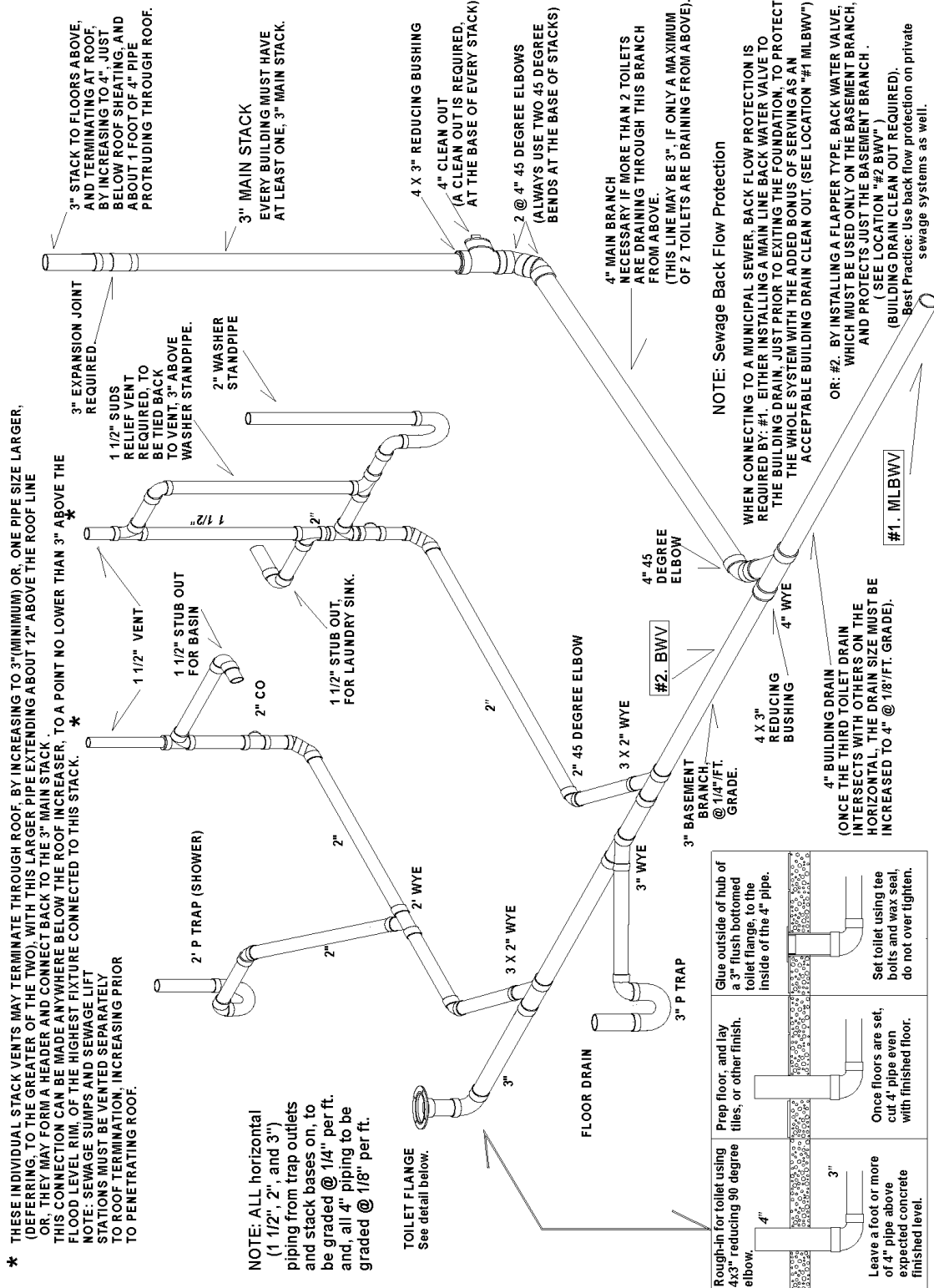

PLUMBING A KITCHEN SINK

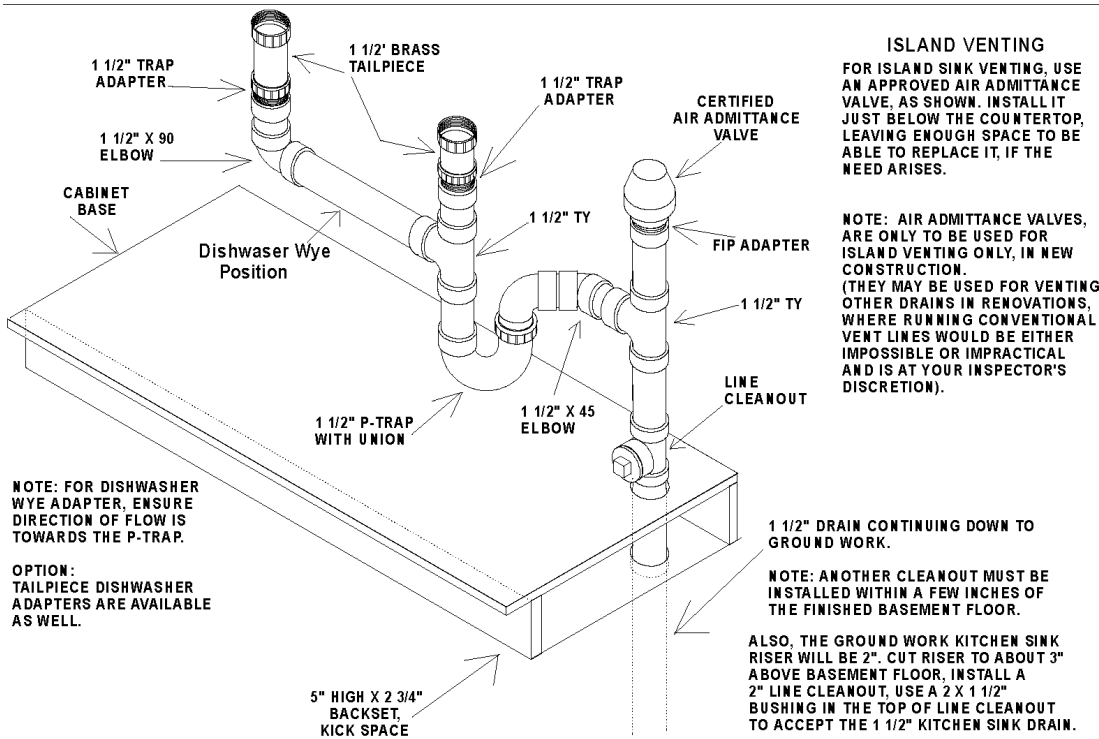
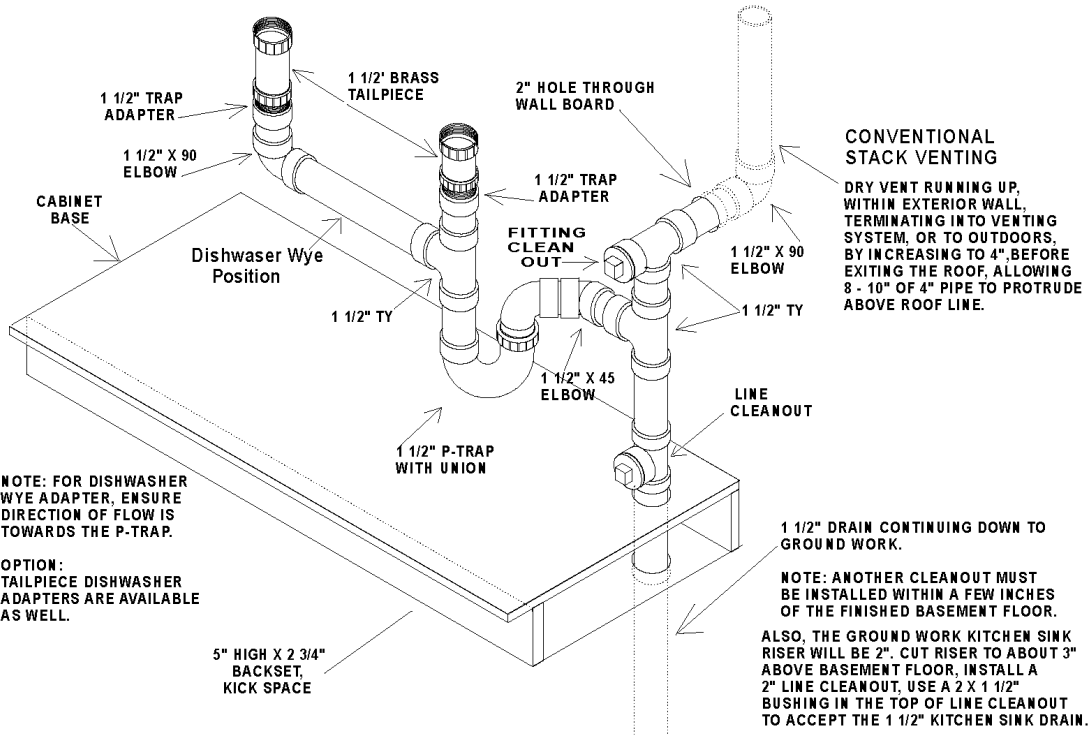

OPEN DISCHARGE

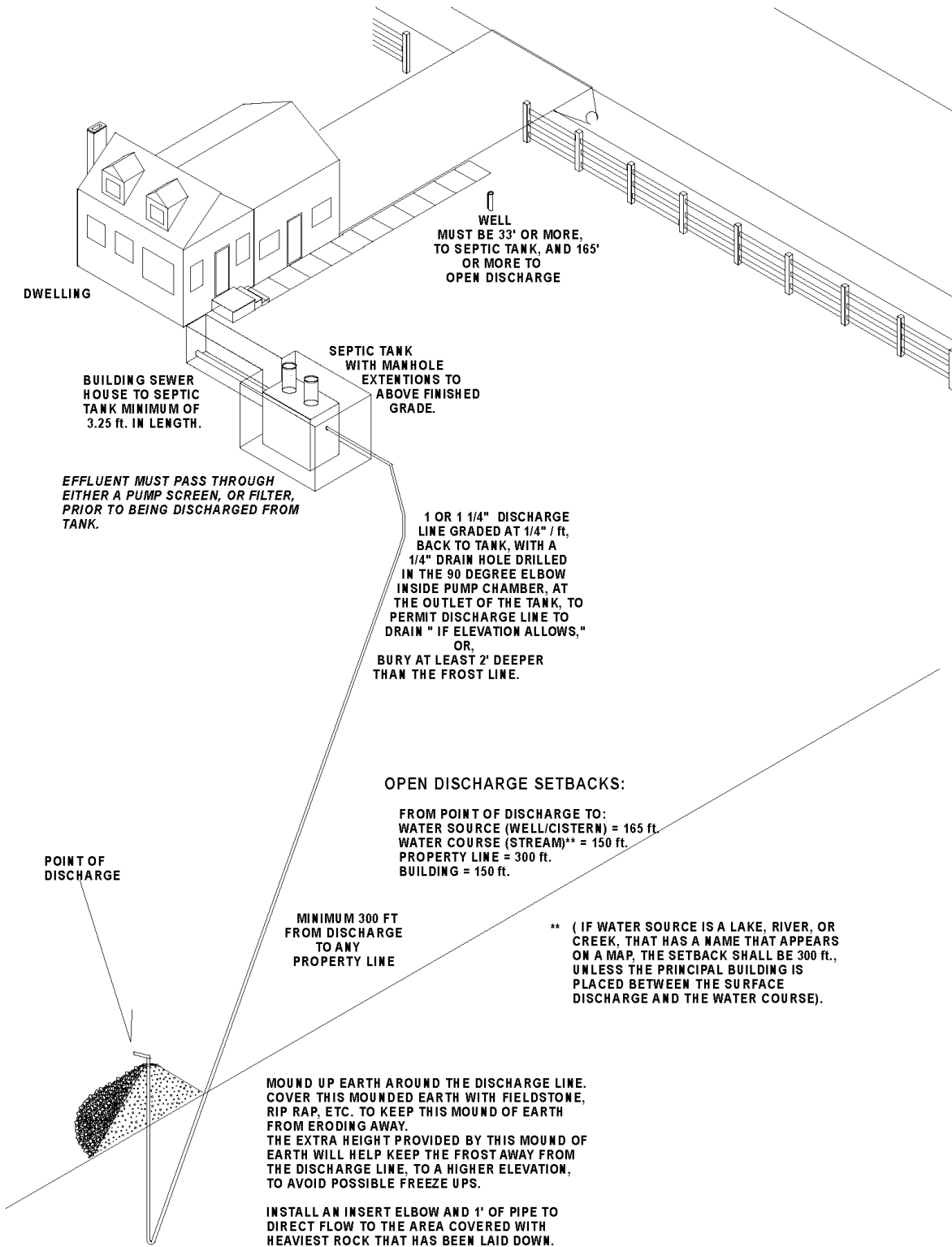

SEPTIC FIELD

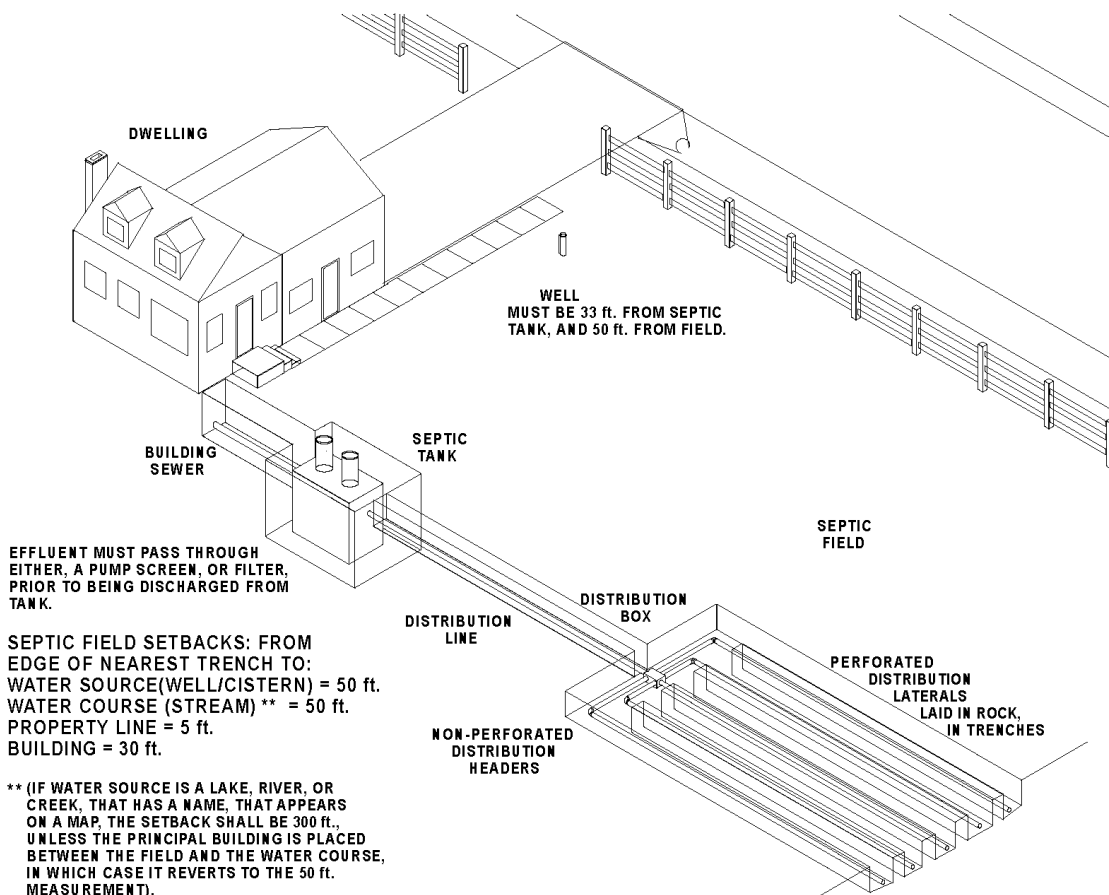

FOR GRAVITY CHAMBER SEPTIC FIELDS LAY 4" NON-PERFORATED DRAIN LINE PIPE FROM HEADER PIPING TO ABOUT 2 FEET THROUGH THE CHAMBER END CAP, INTO THE CHAMBER. ENSURE ABOUT 3" OF WASHED ROCK HAVE BEEN LAID DOWN ACROSS TRENCH BOTTOM, FOR THE LENGTH OF THE FIRST 2 CHAMBERS. LAY CHAMBERS TO THE LENGTH OF TRENCHES. COVER WITH FILTER FABRIC, TO PREVENT BACK FILL FROM INFILTRATING CHAMBER. ALSO, INSTALL A 4" MONITORING PORT WITHIN 15 FEET OF EACH END OF EACH TRENCH. CALL FOR INSPECTION. ONCE INSPECTED, BACK FILL TRENCHES.

FOR PIPE AND ROCK, GRAVITY FIELDS (AS PICTURED), DIG 3 ft. WIDE TRENCHES, SEPARATED BY A MINIMUM 3 ft. OF UNDISTURBED SOIL. LAY 6" OF WASHED ROCK, IN TRENCHES AND RAKE LEVEL. LAY, RIGID 4" PERFORATED DRAIN PIPING IN TRENCH, EACH BEING SUPPLIED SEPARATELY, BY ITS OWN, (NON-PERFORATED), HEADER, FROM THE DISTRIBUTION BOX TO THE LATERAL. NEXT, PLACE 6" OF WASHED ROCK TO COVER PIPING. RAKE LEVEL AND PLACE FILTER FABRIC OVER THE ROCK, (TO PREVENT BACK FILL FROM MIGRATING INTO THE ROCK). INSTALL MONITORING PORTS, CALL FOR INSPECTION. ONCE INSPECTED, BACK FILL THE TRENCHES.

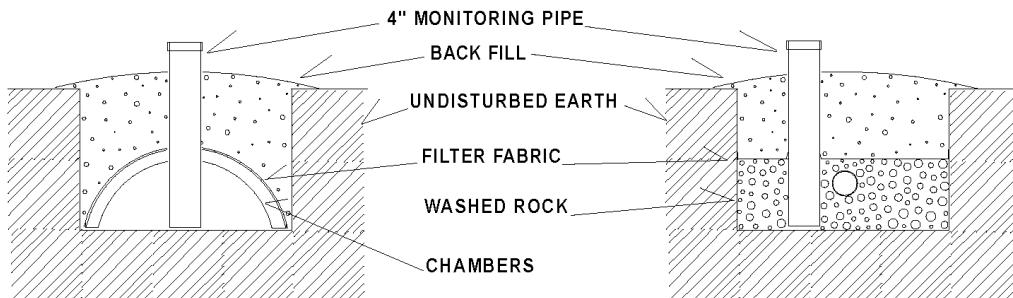

IMPORTANT NOTICE;

WHETHER INSTALLING CHAMBER SYSTEM OR THE PIPE (WASHED) ROCK SYSTEM, ENSURE THAT EACH TRENCH IS AS LEVEL, FROM BEGINNING TO END, AS POSSIBLE. THIS IS VERY IMPORTANT TO THE PROPER FUNCTIONING OF THE FIELD, BY PREVENTING POOLING WITHIN THE TRENCHES.

SEPTIC MOUND

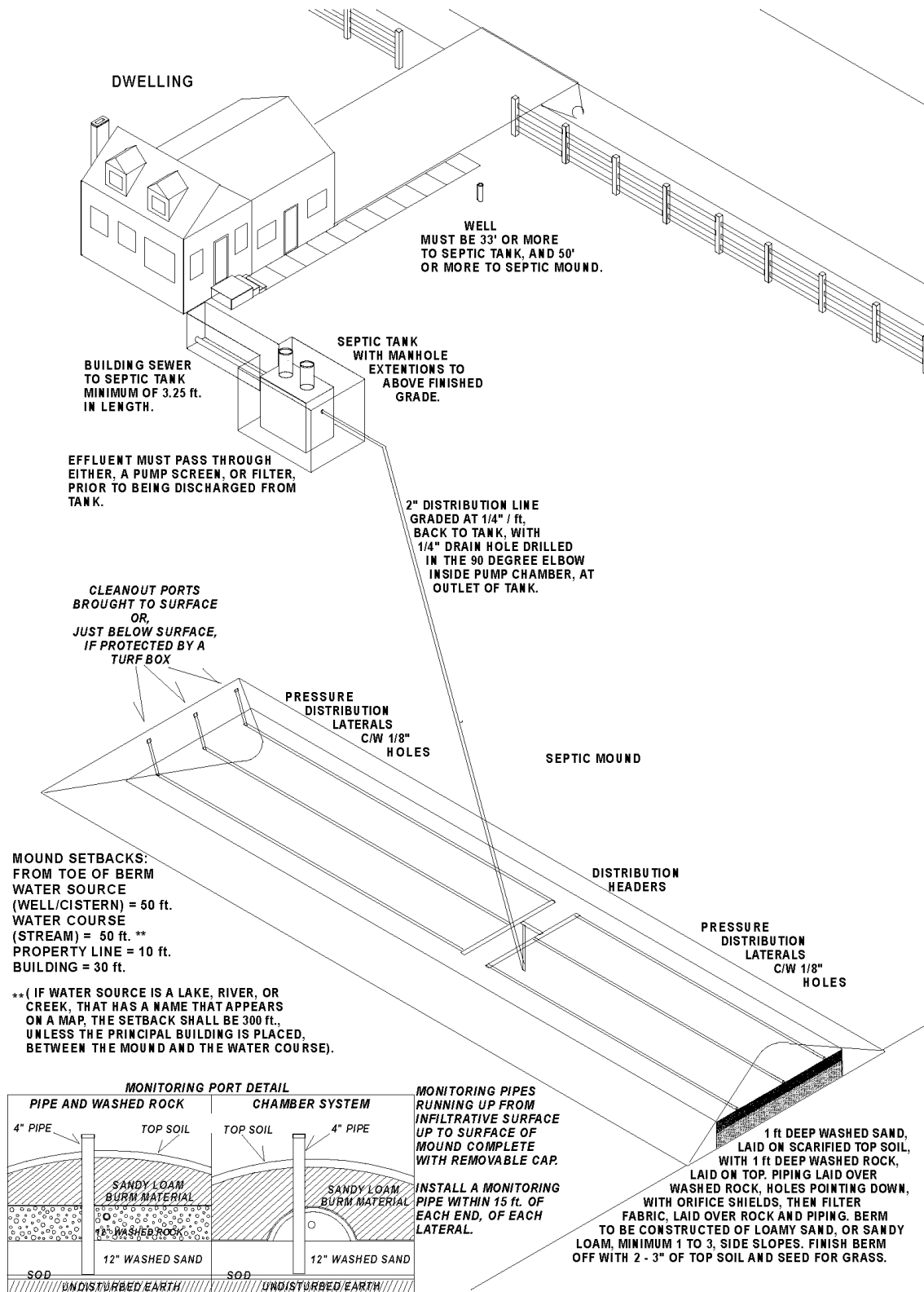

PROPANE CLEARANCES

A. TANKSET CLEARANCES

1. 10 FT. TO ANY BUILDING,
2. 10 FT. TO ANY COMBUSTIBLES, (Any, wood/lumber piles, decks, shelters, driveway/parking areas, etc.)
3. 10 FT. TO ANY IGNITION SOURCE, (Any open flames, BBQ/patio heaters, electrical outlets or switches, vehicles, window a/c unit or compressors, etc.)
4. 10 FT. TO ANY PROPERTY LINE,
5. 10 FT. TO ANY AIR INTAKE, (Intake to any direct vent appliances, or intake to any mechanical ventilation system).

B. LINE REGULATOR CLEARANCES

1. 10 FT. TO ANY IGNITION SOURCE, (open flame, BBQs/patio heaters, electrical outlets or switches, vehicles, window a/c unit or compressors, etc.)
2. 10 FT. TO ANY AIR INTAKE (intake to direct vent appliances, or intake to any mechanical ventilation system).
3. 5 FT. TO ANY BUILDING OPENING (doors, windows, crawl space opening).
4. 1 FT. ABOVE NORMAL SNOW COVER.

A. SERVICE REGULATOR TANK VENT, BELOW TANK HOOD.

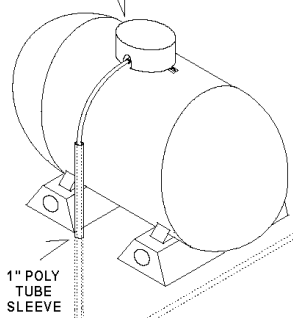

NOTE: THIS OFFSET ALLOWS FOR VERTICAL MOVEMENT.

1" POLY TUBE SLEEVE

MINIMUM SERVICE LINE BURIAL DEPTH IS 15", OR 24" UNDER DRIVEWAYS

RUN POLY SLEEVE FROM ABOUT CENTER LINE OF TANK'S SIDE TO AT LEAST 24" HORIZONTALLY ALONG TRENCH BOTTOM AT TANK END AND, AT LEAST 12" ABOVE GRADE AGAINST BUILDING WALL DOWN TO AT LEAST 24" HORIZONTALLY ALONG TRENCH BOTTOM. REMEMBER TO SEAL EXPOSED SLEEVE ENDS TO TUBING, TO PREVENT MOISTURE FROM ENTERING SLEEVE.

B.

2ND STAGE LINE REGULATOR VENT

LINE ENTERING BUILDING

BUILDING FOUNDATION

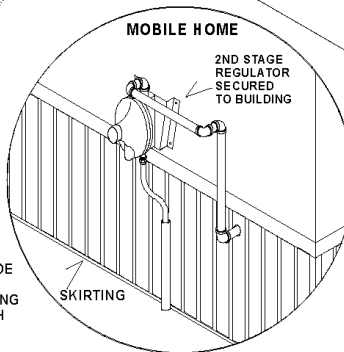

NATURAL GAS SERVICE RISER AND METER SET CONNECTION

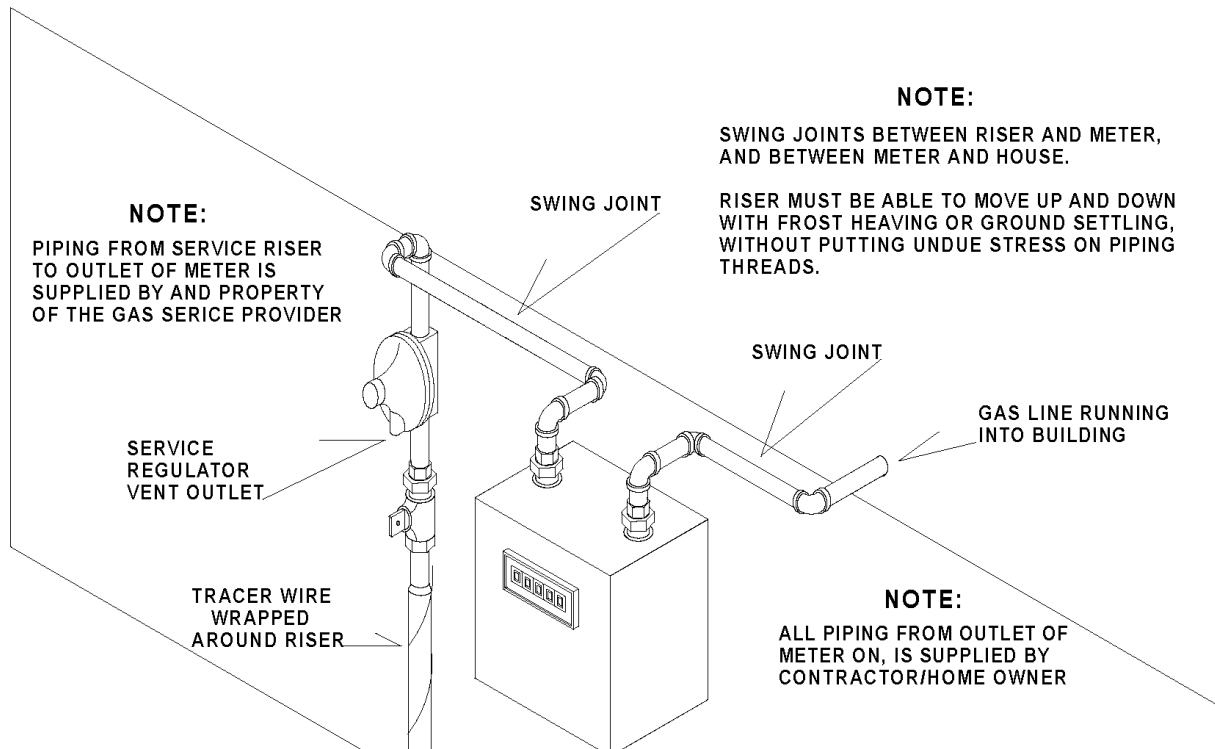

NOTE:
PIPING FROM SERVICE RISER TO OUTLET OF METER IS SUPPLIED BY AND PROPERTY OF THE GAS SERVICE PROVIDER

NOTE:
SWING JOINTS BETWEEN RISER AND METER, AND BETWEEN METER AND HOUSE.
RISER MUST BE ABLE TO MOVE UP AND DOWN WITH FROST HEAVING OR GROUND SETTLING, WITHOUT PUTTING UNDUE STRESS ON PIPING THREADS.

NOTE:
ALL PIPING FROM OUTLET OF METER ON, IS SUPPLIED BY CONTRACTOR/HOME OWNER

CLEARANCES

FOR METER SET LOCATION:

1. A DIRECT UNOBSTRUCTED LINE FROM GAS MAIN TO GAS METER, AND
2. 1 m EITHER SIDE OF RISER.

FROM VENT OUTLET:

- A. THE FOLLOWING MUST BE 1 m FROM REGULATOR VENT:
 1. NON-MECHANICAL (atmospheric) AIR INTAKE,
 2. APPLIANCE EXHAUST VENT FROM NON-GAS APPLIANCE, OR GAS DRYER EXHAUST VENT.
 3. ELECTRICAL OUTLET, OPEN FLAME BBQ, OR
 4. OTHER SOURCES OF POTENTIAL IGNITION, AND
 5. ANY BUILDING OPENING, INCLUDES ALL DOORS AND WINDOWS.
- B. MUST BE 1 m EITHER SIDE, TO A HEIGHT OF 4.5 m AWAY FROM REGULATOR VENT OUTLET:
 1. AN APPLIANCE EXHAUST OUTLET.
(NOTE: KEEP DIRECT VENT FURNACE AND BOILER VENTS, THAT CAN CAUSE ICE BUILD UP, AWAY FROM METER LOCATION REGARDLESS OF HEIGHT).
- C. MUST BE 3 m RADIALLY AWAY FROM VENT AND, 1 m EITHER SIDE, TO A HEIGHT OF 4.5 m ABOVE THE 3 m RADIUS:
 1. A MECHANICAL (FAN ASSISTED) AIR INTAKE.
- D. MUST BE HIGHER FROM VENT TO OVER HANG THAN DEPTH OF OVERHANG.

NOTE: IF NECESSARY, VENT MAY BE PIPED TO A MORE SUITABLE LOCATION.

1. REMOVE THE BUG SCREEN FROM VENT OUTLET AND,
2. THREAD IN A NIPPLE AND ELBOW, TO DIRECT VENT PIPING AWAY,
3. ENSURE THAT VENT TERMINATES AT LEAST 1 FOOT ABOVE GRADE OR ABOVE AVERAGE SNOW FALL, WHICH EVER IS GREATER.
4. REMEMBER TO REINSTALL BUG SCREEN INTO A DOWN TURNED ELBOW AT THE END OF THE VENT LINE.

NATURAL GAS METER SET WITH CONNECTION TO SECONDARY RISER

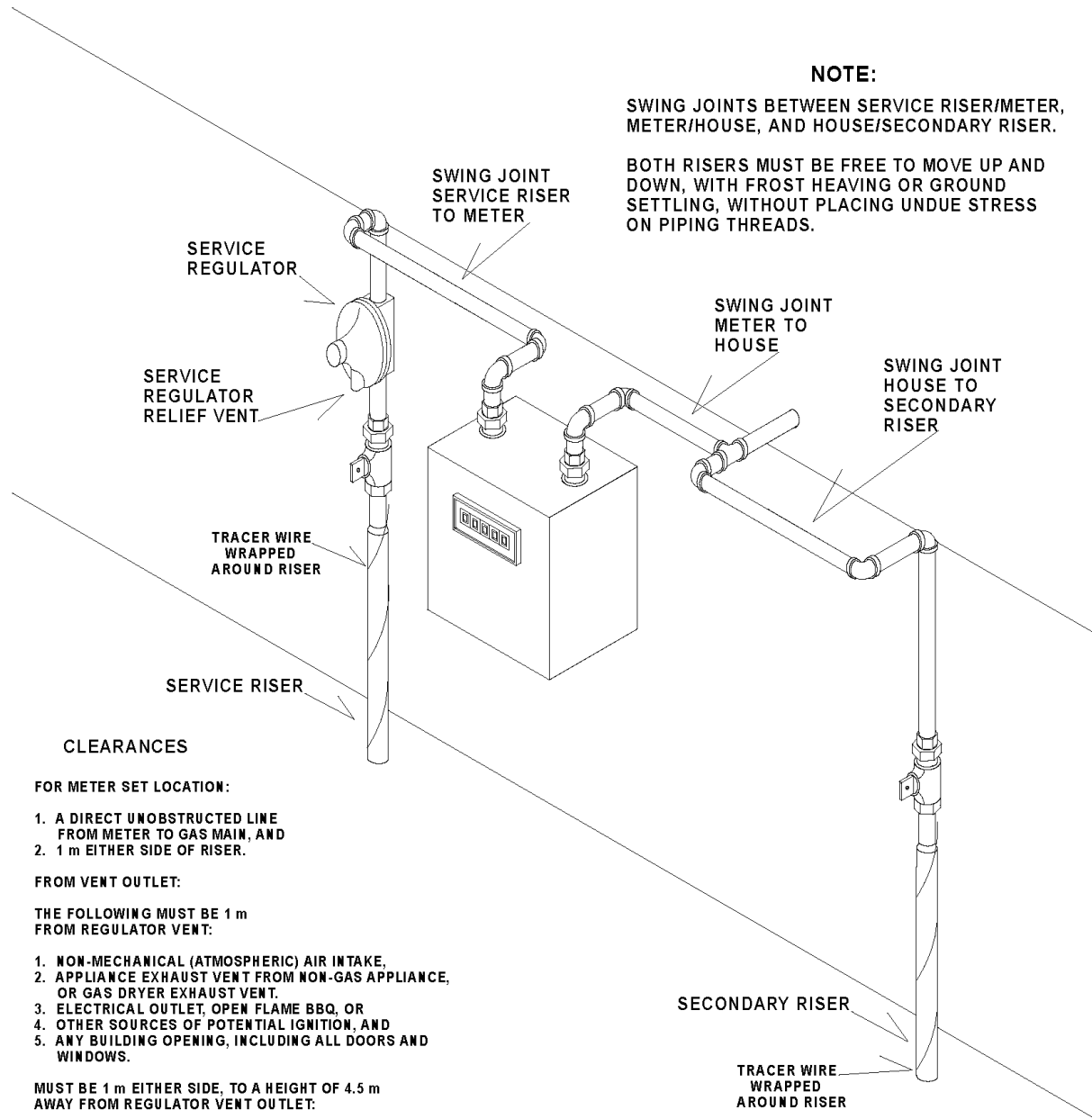

CLEARANCES

FOR METER SET LOCATION:

1. A DIRECT UNOBSTRUCTED LINE FROM METER TO GAS MAIN, AND
2. 1 m EITHER SIDE OF RISER.

FROM VENT OUTLET:

THE FOLLOWING MUST BE 1 m FROM REGULATOR VENT:

1. NON-MECHANICAL (ATMOSPHERIC) AIR INTAKE,
2. APPLIANCE EXHAUST VENT FROM NON-GAS APPLIANCE, OR GAS DRYER EXHAUST VENT.
3. ELECTRICAL OUTLET, OPEN FLAME BBQ, OR
4. OTHER SOURCES OF POTENTIAL IGNITION, AND
5. ANY BUILDING OPENING, INCLUDING ALL DOORS AND WINDOWS.

MUST BE 1 m EITHER SIDE, TO A HEIGHT OF 4.5 m AWAY FROM REGULATOR VENT OUTLET:

1. AN APPLIANCE EXHAUST OUTLET. (NOTE: KEEP DIRECT VENT FURNACE AND BOILER VENTS THAT CAN CAUSE ICE BUILD UP AWAY FROM GAS METER LOCATION REGARDLESS OF HEIGHT).

MUST BE 3 m RADIALLY AWAY FROM VENT AND, 1 METRE EITHER SIDE, TO A HEIGHT OF 4.5 m ABOVE THE 3 m RADIUS:

1. A MECHANICAL (FAN ASSISTED) AIR INTAKE.

MUST BE HIGHER FROM VENT TO OVERHANG, THAN DEPTH OF OVERHANG.

NOTE: VENT MAY BE PIPED TO A MORE SUITABLE LOCATION, BY REMOVING THE BUG SCREEN FROM VENT OUTLET AND THREADING IN AN ELBOW TO DIRECT VENT PIPING AWAY. REMEMBER TO REINSTALL BUG SCREEN IN TO DOWN TURNED ELBOW AT END OF VENT LINE.

ELECTRICAL RESIDENTIAL AERIAL SERVICE ATTACHMENT

TYPICAL RESIDENTIAL AERIAL SERVICE ATTACHMENT DETAILS
 MAXIMUM SERVICE SPAN DISTANCE 30 METERS
 SERVICE ATTACHMENT MUST BE ON POLE LINE SIDE OF BUILDING

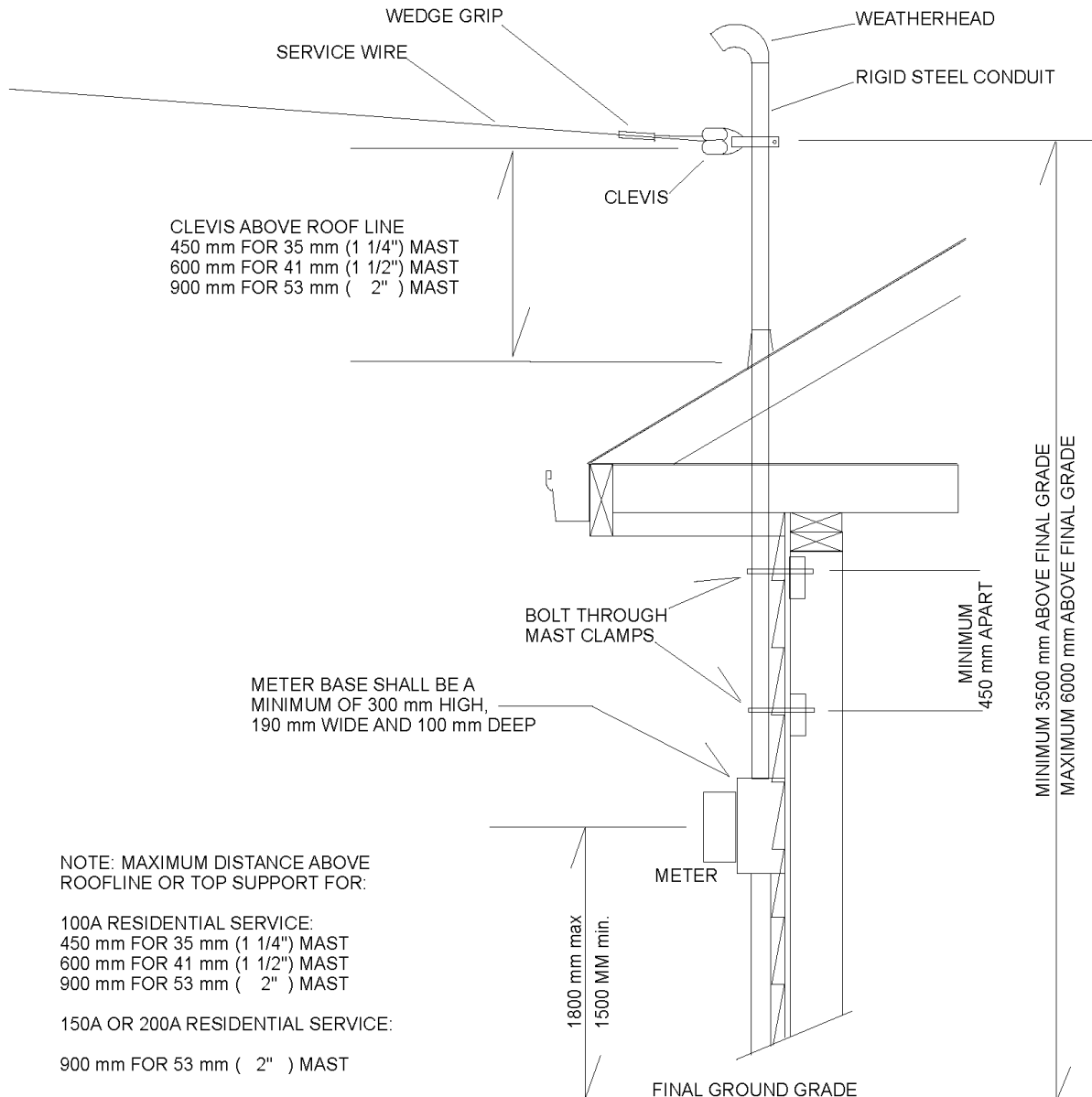

ELECTRICAL RESIDENTIAL AERIAL SERVICE INSTALLATION

TYPICAL RESIDENTIAL AERIAL SERVICE INSTALLATION
 (MAXIMUM SERVICE SPAN DISTANCE 30 METERS)
 SERVICE ATTACHMENT MUST BE ON THE POLE SIDE OF THE BUILDING

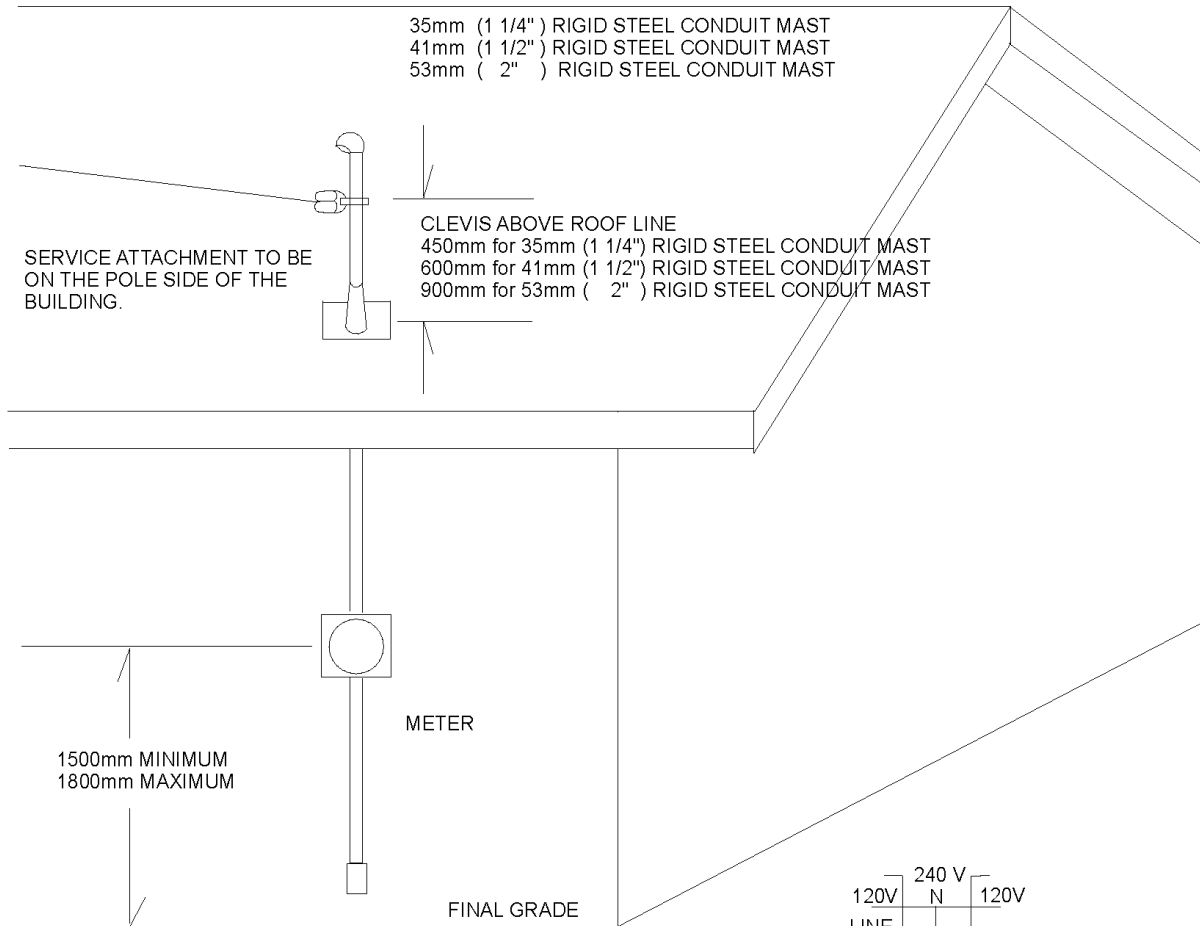

NOTE: MAXIMUM DISTANCE ABOVE ROOF LINE OR TOP SUPPORT FOR:

100A RESIDENTIAL SERVICE:

450 mm for 35 mm (1 1/4") MAST
 600 mm for 41 mm (1 1/2") MAST
 900 MM for 53 mm (2") MAST

150A or 200A RESIDENTIAL SERVICE:

900 mm for 35 mm (2") MAST

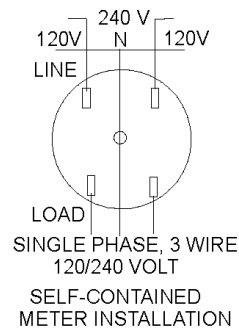

COMMON BRANCH CIRCUITS

All 5-15R and 5-20R receptacles shall be tamper resistant, except for receptacles dedicated for stationary appliances such that the receptacle is rendered inaccessible, or receptacles located 2M or greater above the floor. All 5-15R and 5-20R receptacles shall be arc fault protected except for:

- a) kitchen counter receptacles, peninsula and island receptacles
- b) bathroom receptacles within 1M of bathroom sinks
- c) sump pump single receptacles
- d) fridge receptacles located in kitchen
- e) detached garage receptacles

All other receptacles shall be arc fault protected.

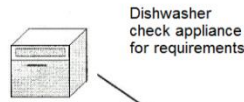

Refrigerator in kitchen only
14/2 wire
15 amp separate circuit

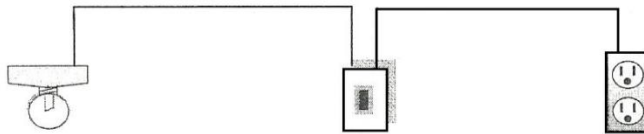
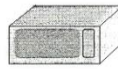
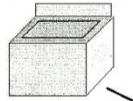

Garage plugs and lights on separate circuit
14/2 wire
15 amp breaker

Kitchen counter split receptacles
max. 2 on a 15 amp 2 pole breaker
14/2 NMD

Kitchen counter 20 amp t-slot receptacles
max. 2 on a 20 amp breaker
12/2 NMD

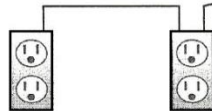

Kitchen counter receptacles within 59"
(1.5M) of sink must be GFCI protected

Bathroom plug outlet
14/2 wire
15 amp breaker
GFI type receptacle required



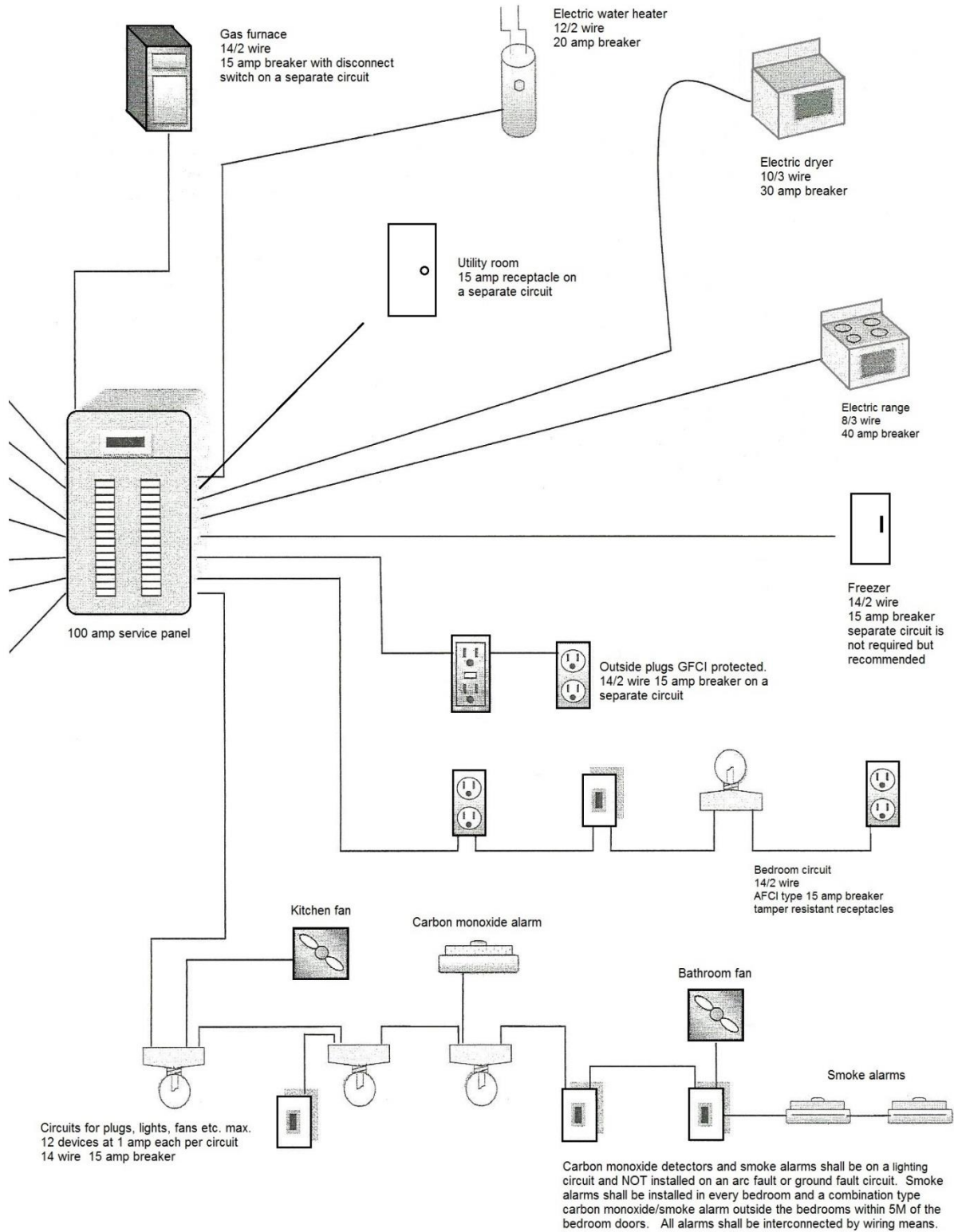

ELECTRICAL RESIDENTIAL UNDERGROUND SERVICE INSTALLATION

CHECK YOUR LOCAL MUNICIPAL GUIDELINES

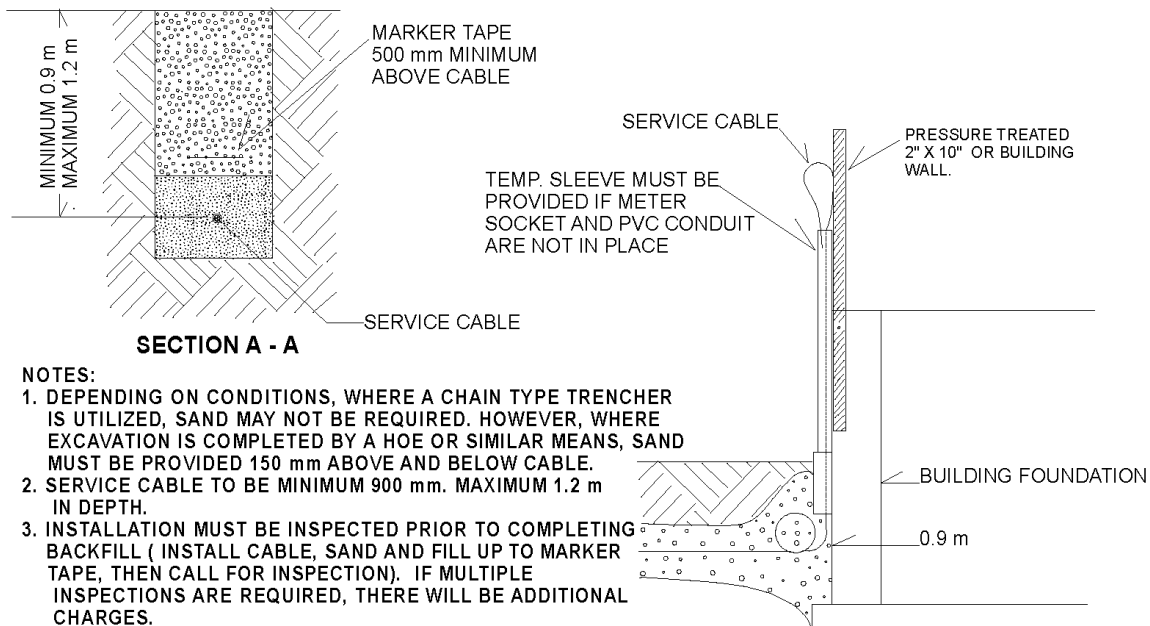
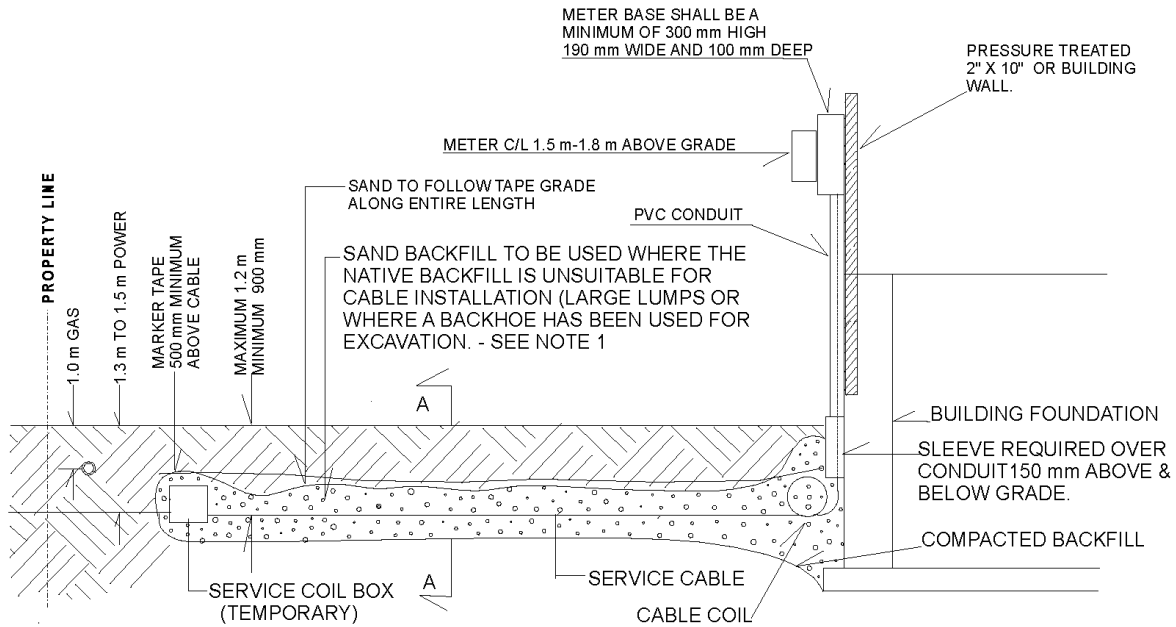

NOTES:

1. DEPENDING ON CONDITIONS, WHERE A CHAIN TYPE TRENCHER IS UTILIZED, SAND MAY NOT BE REQUIRED. HOWEVER, WHERE EXCAVATION IS COMPLETED BY A HOE OR SIMILAR MEANS, SAND MUST BE PROVIDED 150 mm ABOVE AND BELOW CABLE.
2. SERVICE CABLE TO BE MINIMUM 900 mm. MAXIMUM 1.2 m IN DEPTH.
3. INSTALLATION MUST BE INSPECTED PRIOR TO COMPLETING BACKFILL (INSTALL CABLE, SAND AND FILL UP TO MARKER TAPE, THEN CALL FOR INSPECTION). IF MULTIPLE INSPECTIONS ARE REQUIRED, THERE WILL BE ADDITIONAL CHARGES.
4. CABLE MUST BE PROTECTED FROM MECHANICAL DAMAGE AT ALL TIMES.
5. INSTALLATIONS THAT ARE NOT IN COMPLIANCE WILL BE REJECTED.

CABLE DETAIL IF NO METER SOCKET.



www.inspectionsgroup.com

EDSON

Phone: 780 723 4923
Fax: 780 723 3991

EDMONTON

Phone: 780 454 5048
Fax: 780 454 5222

COLD LAKE

Phone: 780 594 4301
Fax: 780 594 3720